

Transformers



Contents	Page
Introduction	5/2
Product Range	5/3
Electrical Design	5/4
Transformer Loss Evaluation	5/6
Mechanical Design	5/8
Connection Systems	5/9
Accessories and Protective Devices	5/11
Technical Data Distribution Transformers	5/13
Technical Data Power Transformers	5/18
On-load Tap Changers	5/26
Cast-resin Dry-type Transformers, GEAFOLE	5/27
Technical Data GEAFOLE Cast-resin Dry-type Transformers	5/31
Special Transformers	5/35

Introduction

Transformers are one of the primary components for the transmission and distribution of electrical energy. Their design results mainly from the range of application, the construction, the rated power and the voltage level.

The scope of transformer types starts with generator transformers and ends with distribution transformers.

Transformers which are directly connected to the generator of the power station are called generator transformers. Their power range goes up to far above 1000 MVA. Their voltage range extends to approx. 1500 kV.

The connection between the different high-voltage system levels is made via network transformers (network interconnecting transformers). Their power range exceeds 1000 MVA. The voltage range exceeds 1500 kV.

Distribution transformers are within the range from 50 to 2500 kVA and max. 36 kV. In the last step, they distribute the electrical energy to the consumers by feeding from the high-voltage into the low-voltage distribution network. These are designed either as liquid-filled or as dry-type transformers.

Transformers with a rated power up to 2.5 MVA and a voltage up to 36 kV are referred to as distribution transformers; all transformers of higher ratings are classified as power transformers.

In addition, there are various special-purpose transformers such as converter transformers, which can be both in the range of power transformers and in the range of distribution transformers as far as rated power and rated voltage are concerned.

As special elements for network stabilization, arc-suppression coils and compensating reactors are available. Arc-suppression coils compensate the capacitive current flowing through a ground fault and thus guarantee uninterrupted energy supply. Compensating reactors compensate the capacitive power of the cable networks and reduce overvoltages in case of load rejection; the economic efficiency and stability of the power transmission are improved.

The general overview of our manufacturing/delivery program is shown in the table "Product Range".

Standards and specifications, general

The transformers comply with the relevant VDE specifications, i.e. DIN VDE 0532 "Transformers and reactors" and the "Technical conditions of supply for three-phase transformers" issued by VDEW and ZVEI.

Therefore they also satisfy the requirements of IEC Publication 76, Parts 1 to 5 together with the standards and specifications (HD and EN) of the European Union (EU).

Enquiries should be directed to the manufacturer where other standards and specifications are concerned. Only the US (ANSI/NEMA) and Canadian (CSA) standards differ from IEC by any substantial degree. A design according to these standards is also possible.

Important additional standards

- DIN 42 500, HD 428: oil-immersed three-phase distribution transformers 50–2500 kVA
- DIN 42 504: oil-immersed three-phase transformers 2–10 MVA
- DIN 42 508: oil-immersed three-phase transformers 12.5–80 MVA
- DIN 42 523, HD 538: three-phase dry-type transformers 100–2500 kVA
- DIN 45 635 T30: noise level
- IEC 289: reactance coils and neutral grounding transformers
- IEC 551: measurement of noise level
- IEC 726: dry-type transformers
- RAL: coating/varnish

	Rated power [MVA]	Max. operating voltage [kV]	Figs. on page
Oil distribution transformers	0.05–2.5	≤ 36	5/13–5/17
Power transformers	2.5–3000	36–1500	5/18–5/25
GEAFOL-cast-resin transformers	0.10–20	≤ 36	5/27–5/34

Fig. 1: Transformer types

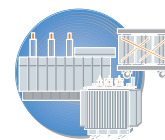

Product Range

	Oil-immersed distribution transformers, TUMETIC, TUNORMA	<ul style="list-style-type: none"> 50 to 2 500 kVA, highest voltage for equipment up to 36 kV, with copper or aluminum windings, hermetically sealed (TUMETIC®) or with conservator (TUNORMA®) of three- or single-phase design
	Generator and power transformers	<ul style="list-style-type: none"> Above 2.5 MVA up to more than 1000 MVA, above 30 kV up to 1500 kV (system and system interconnecting transformers, with separate windings or auto-connected), with on-load tap changers or off-circuit tap changers, of three- or single-phase design
	Cast-resin distribution and power transformers GEAFOLE	<ul style="list-style-type: none"> 100 kVA to more than 20 MVA, highest voltage for equipment up to 36 kV, of three- or single-phase design GEAFOLE®-SL substations
	Special transformers for industry, traction and HVDC transmission systems	<ul style="list-style-type: none"> Furnace and converter transformers Traction transformers mounted on rolling stock and appropriate on-load tap-changers Substation transformers for traction systems Transformers for train heating and point heating Transformers for HVDC transmission systems Transformers for audio frequencies in power supply systems Three-phase neutral electromagnetic couplers and grounding transformers Ignition transformers
	Reactors	<ul style="list-style-type: none"> Liquid-immersed shunt and current-limiting reactors up to the highest rated powers Reactors for HVDC transmission systems
	Accessories	<ul style="list-style-type: none"> Buchholz relays, oil testing equipment, oil flow indicators and other monitoring devices Fan control cabinets, control cabinets for parallel operation and automatic voltage control Sensors (PTC, Pt 100)
	Service	<ul style="list-style-type: none"> Advisory services for transformer specifications Organization, coordination and supervision of transportation Supervision of assembly and commissioning Service/inspection troubleshooting services Training of customer personnel Investigation and assessment of oil problems

Fig. 2

Electrical Design

Power ratings and type of cooling

All power ratings in this guide are the product of rated voltage (times phase-factor for three-phase transformers) and rated current of the line side winding (at center tap, if several taps are provided), expressed in kVA or MVA, as defined in IEC 76-1. If only one power rating and no cooling method are shown, natural oil-air cooling (ONAN or OA) is implied for oil-immersed transformers. If two ratings are shown, forced-air cooling (ONAF or FA) in one or two steps is applicable.

For cast resin transformers, natural air cooling (AN) is standard. Forced air cooling (AF) is also applicable.

Temperature rise

In accordance with IEC-76 the standard temperature rise for oil-immersed power and distribution transformers is:

- 65 K average winding temperature (measured by the resistance method)
- 60 K top oil temperature (measured by thermometer)

The standard temperature rise for Siemens cast-resin transformers is

- 100 K (insulation class F) at HV and LV winding.

Whereby the standard ambient temperatures are defined as follows:

- 40 °C maximum temperature,
- 30 °C average on any one day,
- 20 °C average in any one year,
- -25 °C lowest temperature outdoors,
- -5 °C lowest temperature indoors.

Higher ambient temperatures require a corresponding reduction in temperature rise, and thus affect price or rated power as follows:

- 1.5% surcharge for each 1 K above standard temperature conditions, or
- 1.0% reduction of rated power for each 1 K above standard temperature conditions.

These adjustment factors are applicable up to 15 K above standard temperature conditions.

Altitude of installation

The transformers are suitable for operation at altitudes up to 1000 meters above sea level. Site altitudes above 1000 m necessitate the use of special designs and an increase/or a reduction of the transformer ratings as follows (approximate values):

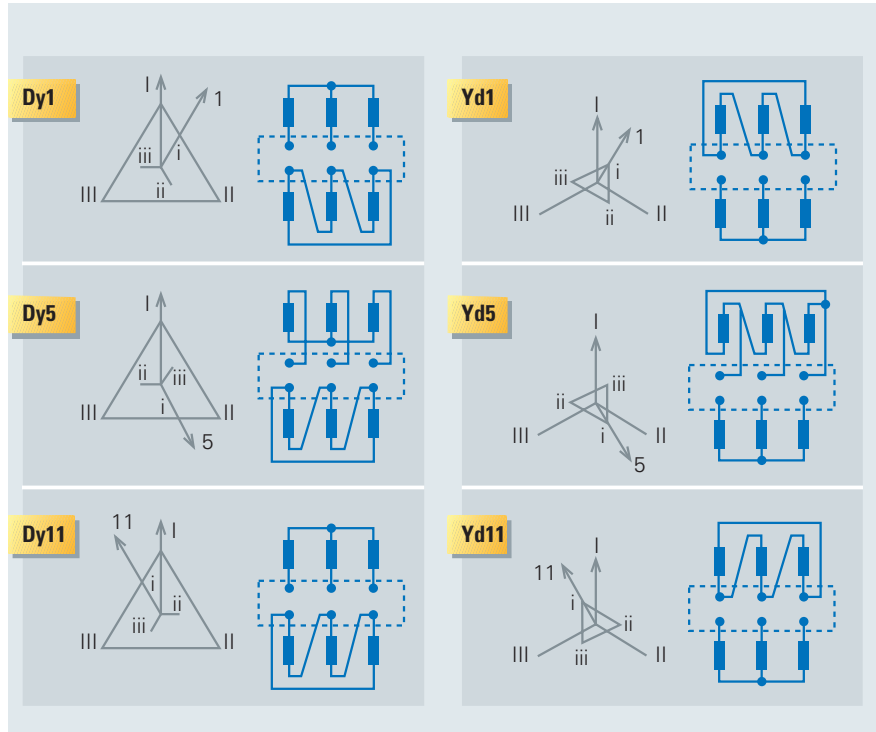

Fig. 3: Most commonly used vector groups

- 2% increase for every 500 m altitude (or part there of) in excess of 1000 m, or
- 2% reduction of rated power for each 500 m altitude (or part there of) in excess of 1000 m.

Transformer losses and efficiencies

Losses and efficiencies stated in this guide are average values for guidance only. They are applicable if no loss evaluation figure is stated in the inquiry (see following chapter) and they are subject to the tolerances stated in IEC 76-1, namely +10% of the total losses, or +15% of each component loss, provided that the tolerance for the total losses is not exceeded.

If optimized and/or guaranteed losses without tolerances are required, this must be stated in the inquiry.

Connections and vector groups

Distribution transformers

The transformers listed in this guide are all three-phase transformers with one set of windings connected in star (wye) and the other one in delta, whereby the neutral of the star-connected winding is fully rated and brought to the outside.

The primary winding (HV) is normally connected in delta, the secondary winding (LV) in wye. The electrical offset of the windings in respect to each other is either 30, 150 or 330 degrees standard (Dy1, Dy5, Dy11). Other vector groups as well as single-phase transformers and autotransformers on request (Fig. 3).

Power transformers

Generator transformers and large power transformers are usually connected in Yd. For HV windings higher than 110 kV, the neutral has a reduced insulation level. For star/star-connected transformers and autotransformers normally a tertiary winding in delta, whose rating is a third of that of the transformer, has to be added. This stabilizes the phase-to phase voltages in the case of an unbalanced load and prevents the displacement of the neutral point.

Single-phase transformers and autotransformers are used when the transportation possibilities are limited. They will be connected at site to three-phase transformer banks.

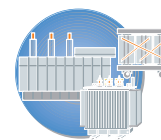

Electrical Design

Insulation level

Power-frequency withstand voltages and lightning-impulse withstand voltages are in accordance with IEC 76-3, Para. 5, Table II, as follows:

Highest voltage for equipment U_m (r. m. s.)	Rated short-duration power-frequency withstand voltage (r. m. s.)	Rated lightning-impulse withstand voltage (peak)	
		List 1 [kV]	List 2 [kV]
≤ 1.1	3	–	–
3.6	10	20	40
7.2	20	40	60
12.0	28	60	75
17.5	38	75	95
24.0	50	95	125
36.0	70	145	170
52.0	95	250	
72.5	140	325	
123.0	185	450	
145.0	230	550	
170.0	275	650	
170.0	325	750	
170.0	360	850	
245.0	395	950	

Higher test voltage withstand requirements must be stated in the inquiry and may result in a higher price.

Fig. 4: Insulation level

Conversion to 60 Hz – possibilities

All ratings in the selection tables of this guide are based on 50 Hz operation. For 60 Hz operation, the following options apply:

- 1. Rated power and impedance voltage are increased by 10%, all other parameters remain identical.
- 2. Rated power increases by 20%, but no-load losses increase by 30% and noise level increases by 3 dB, all other parameters remain identical (this layout is not possible for cast-resin transformers).
- 3. All technical data remain identical, price is reduced by 5%.
- 4. Temperature rise is reduced by 10 K, load losses are reduced by 15%, all other parameters remain identical.

Overloading

Overloading of Siemens transformers is guided by the relevant IEC-354 "Loading guide for oil-immersed transformers" and the (similar) ANSI C57.92 "Guide for loading mineral-oil-immersed power transformers".

Overloading of GEAFOL cast-resin transformers on request.

Routine and special tests

All transformers are subjected to the following routine tests in the factory:

- Measurement of winding resistance
- Measurement of voltage ratio and check of polarity or vector group
- Measurement of impedance voltage
- Measurement of load loss
- Measurement of no-load loss and no-load current
- Induced overvoltage withstand test
- Separate-source voltage withstand test
- Partial discharge test (only GEAFOL cast-resin transformers).

The following special tests are optional and must be specified in the inquiry:

- Lightning-impulse voltage test (LI test), full-wave and chopped-wave (specify)
- Partial discharge test
- Heat-run test at natural or forced cooling (specify)
- Noise level test
- Short-circuit test.

Test certificates are issued for all the above tests on request.

Transformer cell (indoor installation)

The transformer cell must have the necessary electrical clearances when an open air connection is used. The ventilation system must be large enough to fulfill the recommendations for the maximum temperatures according to IEC.

For larger power transformers either an oil/water cooling system has to be used or the oil/air cooler (radiator bank) has to be installed outside the transformer cell.

In these cases a ventilation system has to be installed also to remove the heat caused by the convection of the transformer tank.

Transformer Loss Evaluation

The sharply increased cost of electrical energy has made it almost mandatory for buyers of electrical machinery to carefully evaluate the inherent losses of these items. In case of distribution and power transformers, which operate continuously and most frequently in loaded condition, this is especially important. As an example, the added cost of loss-optimized transformers can in most cases be recovered via savings in energy use in less than three years.

Low-loss transformers use more and better materials for their construction and thus initially cost more. By stipulating loss evaluation figures in the transformer inquiry, the manufacturer receives the necessary incentive to provide a loss-optimized transformer rather than the low-cost model.

Detailed loss evaluation methods for transformers have been developed and are described accurately in the literature, taking the project-specific evaluation factors of a given customer into account.

The following simplified method for a quick evaluation of different quoted transformer losses is given, making the following assumptions:

- The transformers are operated continuously
- The transformers operate at partial load, but this partial load is constant
- Additional cost and inflation factors are not considered
- Demand charges are based on 100% load.

The total cost of owning and operating a transformer for one year is thus defined as follows:

- A. Capital cost C_c taking into account the purchase price C_p , the interest rate p , and the depreciation period n
- B. Cost of no-load loss C_{P_0} , based on the no-load loss P_0 , and energy cost C_e
- C. Cost of load loss C_{P_k} , based on the copper loss P_k , the equivalent annual load factor α , and energy cost C_e
- D. Demand charges C_d , based on the amount set by the utility, and the total kW of connected load.

These individual costs are calculated as follows:

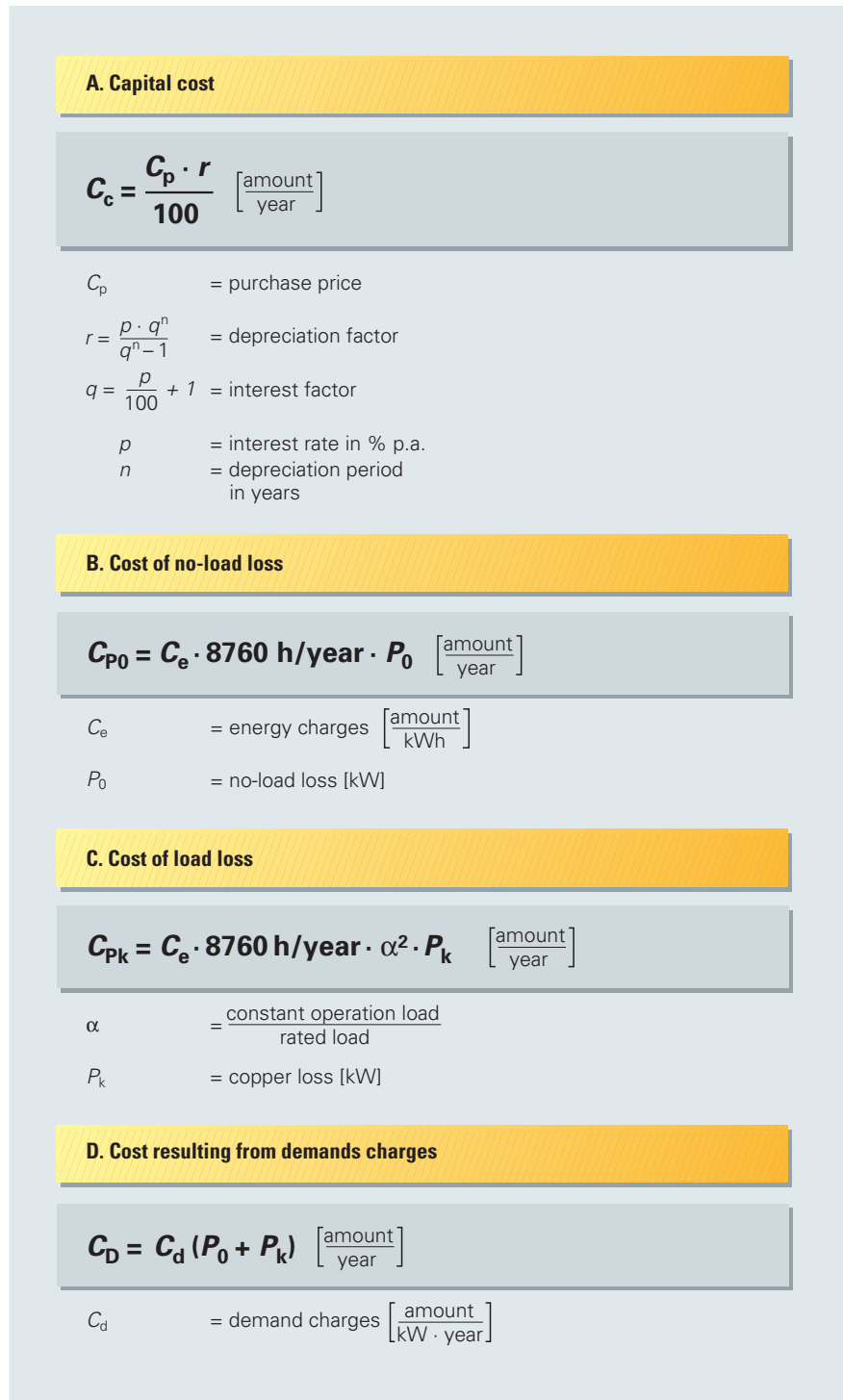
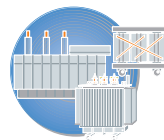

Fig. 5



Transformer Loss Evaluation

To demonstrate the usefulness of such calculations, the following arbitrary examples are shown, using factors that can be considered typical in Germany, and neglecting the effects of inflation on the rate assumed:

Example: 1600 kVA distribution transformer

Depreciation period	$n = 20$ years	Depreciation factor $r = 13.39$
Interest rate	$p = 12\%$ p. a.	
Energy charge	$C_e = 0.25$ DM/kWh	
Demand charge	$C_d = 350 \frac{\text{DM}}{\text{kW} \cdot \text{yr}}$	
Equivalent annual load factor	$\alpha = 0.8$	

A. Low-cost transformer

$P_0 = 2.6$ kW	no-load loss
$P_k = 20$ kW	load loss
$C_p = \text{DM } 25\,000$	purchase price

$$C_c = \frac{25000 \cdot 13.39}{100}$$

$$= \text{DM } 3348/\text{year}$$

$$C_{P0} = 0.25 \cdot 8760 \cdot 2.6$$

$$= \text{DM } 5694/\text{year}$$

$$C_{Pk} = 0.25 \cdot 8760 \cdot 0.64 \cdot 20$$

$$= \text{DM } 28032/\text{year}$$

$$C_D = 350 \cdot (2.6 + 20)$$

$$= \text{DM } 7910/\text{year}$$

Total cost of owning and operating this transformer is thus:
DM 44 984.-/year

B. Loss-optimized transformer

$P_0 = 1.7$ kW	no-load loss
$P_k = 17$ kW	load loss
$C_p = \text{DM } 28\,000$	purchase price

$$C_c = \frac{28000 \cdot 13.39}{100}$$

$$= \text{DM } 3749/\text{year}$$

$$C_{P0} = 0.25 \cdot 8760 \cdot 1.7$$

$$= \text{DM } 3723/\text{year}$$

$$C_{Pk} = 0.25 \cdot 8760 \cdot 0.64 \cdot 17$$

$$= \text{DM } 23827/\text{year}$$

$$C_D = 350 \cdot (1.7 + 17)$$

$$= \text{DM } 6545/\text{year}$$

Total cost of owning and operating this transformer is thus:
DM 37 844.-/year

The energy saving of the optimized distribution transformer of **DM 7140 per year** pays for the increased purchase price in less than one year.

Fig. 6

Mechanical Design

General mechanical design for oil-immersed transformers:

- Iron core made of grain-oriented electrical sheet steel insulated on both sides, core-type.
- Windings consisting of copper section wire or copper strip. The insulation has a high disruptive strength and is temperature-resistant, thus guaranteeing a long service life.
- Designed to withstand short circuit for at least 2 seconds (IEC).
- Oil-filled tank designed as tank with strong corrugated walls or as radiator tank.
- Transformer base with plain or flanged wheels (skid base available).
- Cooling/insulation liquid: Mineral oil according to VDE 0370/IEC 296. Silicone oil or synthetic liquids are available.
- Standard coating for indoor installation. Coatings for outdoor installation and for special applications (e.g. aggressive atmosphere) are available.

Tank design and oil preservation system

Sealed-tank distribution transformers, TUMETIC®

In ratings up to 2500 kVA and 170 kV LI this is the standard sealed-tank distribution transformer without conservator and gas cushion. The TUMETIC transformer is always completely filled with oil; oil expansion is taken up by the flexible corrugated steel tank (variable volume tank design), whereby the maximum operating pressure remains at only a fraction of the usual. These transformers are always shipped completely filled with oil and sealed for their lifetime. Bushings can be exchanged from the outside without draining the oil below the top of the active part.

The hermetically sealed system prevents oxygen, nitrogen, or humidity from contact with the insulating oil. This improves the aging properties of the oil to the extent that no maintenance is required on these transformers for their lifetime. Generally the TUMETIC transformer is lower than the TUNORMA transformer. This design has been in successful service since 1973. A special TUMETIC-Protection device has been developed for this transformer.

Distribution transformers with conservator, TUNORMA®

This is the standard distribution transformer design in all ratings. The oil level in the tank and the top-mounted bushings is kept constant by a conservator vessel or expansion tank mounted at the highest point of the transformer. Oil-level changes due to thermal cycling affect the conservator only. The ambient air is prevented from direct contact with the insulating oil through oil-traps and dehydrating breathers.

Tanks from 50 to approximately 4000 kVA are preferably of the corrugated steel design, whereby the sidewalls are formed on automatic machines into integral cooling pockets. Suitable spot welds and braces render the required mechanical stability. Tank bottom and cover are fabricated from rolled and welded steel plate.

Conventional radiators are available.

Power transformers

Power transformers of all ratings are equipped with conservators. Both the open and closed system are available.

With the closed system "TUPROTECT®" the oil does not come into contact with the surrounding air. The oil expansion is compensated with an air bag. (This design is also available for greater distribution transformers on request).

The sealing bag consists of strong nylon braid with a special double lining of ozone and oil-resistant nitrile rubber. The interior of this bag is in contact with the ambient air through a dehydrating breather; the outside of this bag is in direct contact with the oil.

All tanks, radiators and conservators (incl. conservator with airbag) are designed for vacuum filling of the oil.

For transformers with on-load tap changers a separate smaller conservator is necessary for the diverter switch compartment. This separate conservator (without air bag) is normally an integrated part of the main conservator with its own magnetic oil level indicator.

Power transformers up to 10 MVA are fitted with weld-on radiators and are shipped extensively assembled; shipping conditions permitting.

Ratings above 10 MVA require detachable radiators with individual butterfly valves, and partial dismantling of components for shipment.

All the usual fittings and accessories for oil treatment, shipping and installation of these transformers are provided as standard. For monitoring and protective devices, see the listing on page 5/11.



Fig. 7: Cross section of a TUMETIC three-phase distribution transformer



Fig. 8: 630 kVA, three-phase, TUNORMA 20 kV \pm 2.5 %/0.4 kV distribution transformer

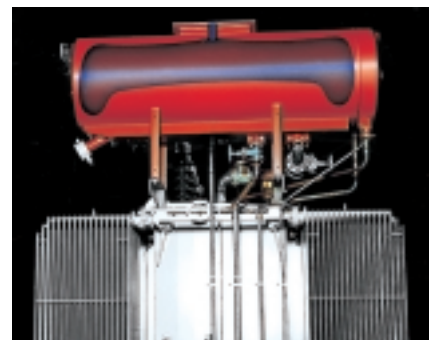
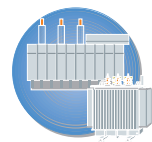

Fig. 9: Practically maintenancefree: transformer with the TUPROTECT air-sealing system built into the conservator



Connection Systems

Distribution transformers

All Siemens transformers have top-mounted HV and LV bushings according to DIN in their standard version. Besides the open bushing arrangement for direct connection of bare or insulated wires, three basic insulated termination systems are available:

Fully enclosed terminal box for cables (Fig. 11)

Available for either HV or LV side, or for both. Horizontally split design in degree of protection IP 44 or IP 54. (Totally enclosed and fully protected against contact with live parts, plus protection against drip, splash, or spray water.)

Cable installation through split cable glands and removable plates facing diagonally downwards. Optional conduit hubs. Suitable for single-core or three-phase cables with solid dielectric insulation, with or without stress cones. Multiple cables per phase are terminated on auxiliary bus structures attached to the bushings. Removal of transformer by simply bending back the cables.



Fig. 11: Fully enclosed cable connection box

Insulated plug connectors (Fig. 12)

For substation installations, suitable HV can be attached via insulated elbow connectors in LI ratings up to 170 kV.



Fig. 12: Grounded metal-elbow plug connectors

Flange connection (Fig. 13)

Air-insulated bus ducts, insulated busbars, or throat-connected switchgear cubicles are connected via standardized flanges on steel terminal enclosures. These can accommodate either HV, LV, or both bushings. Fiberglass-reinforced epoxy partitions are available between HV and LV bushings if flange/flange arrangements are chosen.

The following combinations of connection systems are possible besides open bushing arrangements:

HV	LV
Cable box	Cable box
Cable box	Flange/throat
Flange	Cable box
Flange	Flange/throat
Elbow connector	Cable box
Elbow connector	Flange/throat

Fig. 10: Combination of connection systems



Fig. 13: Flange connection for switchgear and bus ducts

Connection Systems

Power transformers

The most frequently used type of connection for transformers is the outdoor bushing.

Depending on voltage, current, system conditions and transport requirements, the transformers will be supplied with bushings arranged vertically, horizontally or inclined. Up to about 110 kV it is usual to use oil-filled bushings according to DIN; condenser bushings are normally used for higher voltages.

Limited space or other design considerations often make it necessary to connect cables directly to the transformer. For voltages up to 30 kV air-filled cable boxes are used. For higher voltages the boxes are oil-filled. They may be attached to the tank cover or to its walls (Fig. 14).

The space-saving design of SF₆-insulated switchgear is one of its major advantages. The substation transformer is connected directly to the SF₆ switchgear. This eliminates the need for an intermediate link (cable, overhead line) between transformer and system (Fig. 15).

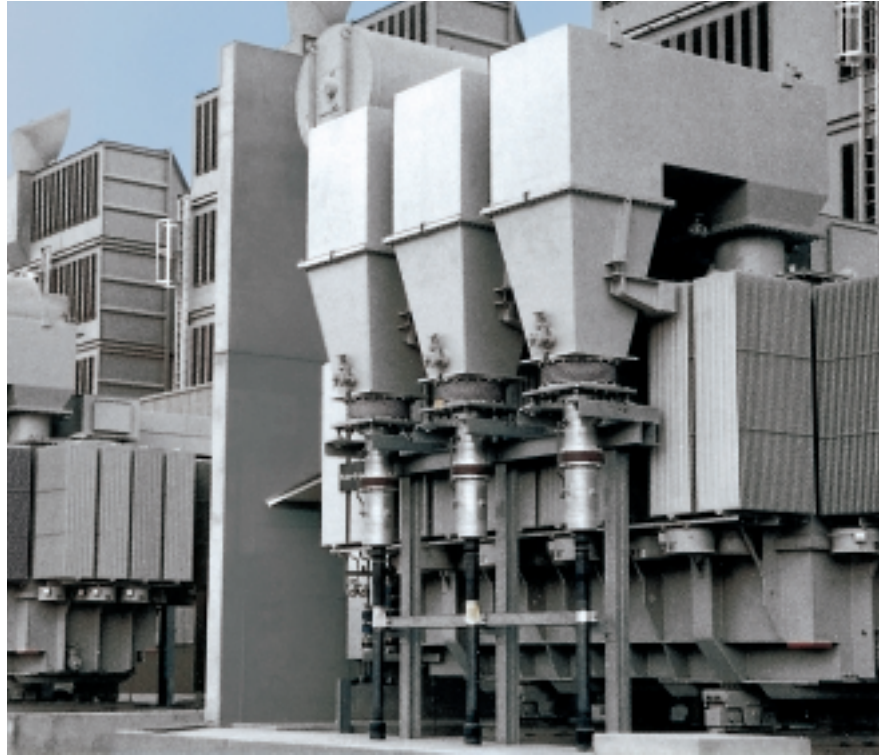
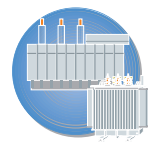

Fig. 14: Transformers with oil-filled HV cable boxes



Fig. 15: Direct SF₆-connection of the transformer to the switchgear



Accessories and Protective Devices

Accessories not listed completely.
Deviations are possible.

Double-float Buchholz relay (Fig. 16)

For sudden pressure rise and gas detection in oil-immersed transformer tanks with conservator. Installed in the connecting pipe between tank and conservator and responding to internal arcing faults and slow decomposition of insulating materials. Additionally, backup function of oil alarm.

The relay is actuated either by pressure waves or gas accumulation, or by loss of oil below the relay level. Separate contacts are installed for alarm and tripping.

In case of a gas accumulation alarm, gas samples can be drawn directly at the relay with a small chemical testing kit. Discoloring of two liquids indicates either arcing by-products or insulation decomposition products in the oil. No change in color indicates an air bubble.



Fig. 16: Double-float Buchholz relay

Dial-type contact thermometer (Fig. 17)

Indicates actual top-oil temperature via capillary tube. Sensor mounted in well in tank cover. Up to four separately adjustable alarm contacts and one maximum pointer are available. Installed to be readable from the ground.

With the addition of a CT-fed thermal replica circuit, the simulated hot-spot winding temperature of one or more phases can be indicated on identical thermometers. These instruments can also be used to control forced cooling equipment.



Fig. 17: Dial-type contact thermometer

Magnetic oil-level indicator (Fig. 18)

The float position inside of the conservator is transmitted magnetically through the tank wall to the indicator to preserve the tank sealing standard device without contacts; devices supplied with limit (position) switches for high- and low-level alarm are available. Readable from the ground.

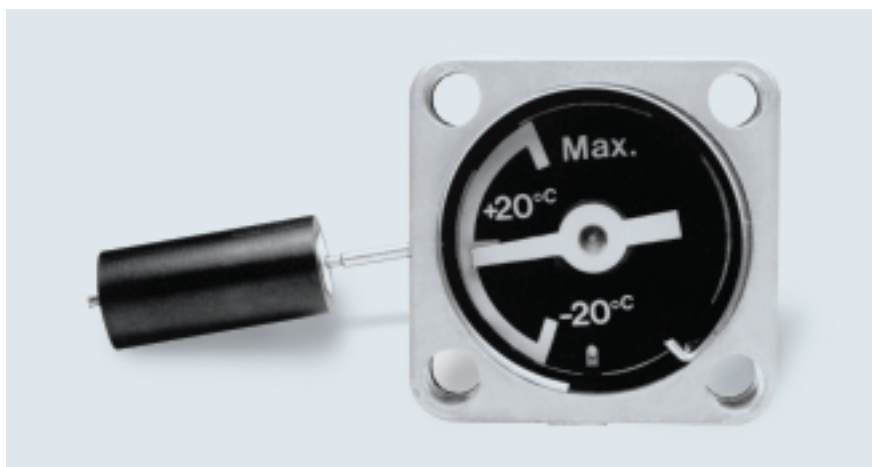

Fig. 18: Magnetic oil-level indicator

Accessories and Protective Devices



Fig. 19: Protective device for hermetically sealed transformers (TUMETIC)



Fig. 20: Pressure relief device with alarm contact and automatic resetting

Protective device (Fig. 19) for hermetically sealed transformers (TUMETIC)

For use on hermetically sealed TUMETIC distribution transformers. Gives alarm upon loss of oil and gas accumulation. Mounted directly at the (permanently sealed) filler pipe of these transformers.

Pressure relief device (Fig. 20)

Relieves abnormally high internal pressure shock waves. Easily visible operation pointer and alarm contact. Reseals positively after operation and continues to function without operator action.

Dehydrating breather (Fig. 21, 22)

A dehydrating breather removes most of the moisture from the air which is drawn into the conservator as the transformer cools down. The absence of moisture in the air largely eliminates any reduction in the breakdown strength of the insulation and prevents any buildup of condensation in the conservator. Therefore, the dehydrating breather contributes to safe and reliable operation of the transformer.



Fig. 21: Dehydrating breather A DIN 42 567 up to 5 MVA



Fig. 22: Dehydrating breather L DIN 42 562 over 5 MVA

Bushing current transformer

Up to three ring-type current transformers per phase can be installed in power transformers on the upper and lower voltage side. These multiratio CTs are supplied in all common accuracy and burden ratings for metering and protection. Their secondary terminals are brought out to short-circuiting-type terminal blocks in watertight terminal boxes.

Additional accessories

Besides the standard accessories and protective devices there are additional items available, especially for large power transformers. They will be offered and installed on request.

Examples are:

- Fiber-optic temperature measurements
- Permanent gas-in-oil analysis
- Permanent water-content measurement
- Sudden pressure rise relay, etc.

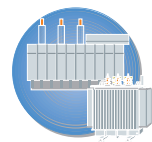

Technical Data Distribution Transformers TUNORMA and TUMETIC

Oil-immersed TUMETIC and TUNORMA three-phase distribution transformers

- Standard: DIN 42500
- Rated power: 50–2500 kVA
- Rated frequency: 50 Hz
- HV rating: up to 36 kV
- Taps on HV side: $\pm 2.5\%$ or $\pm 2 \times 2.5\%$
- LV rating: 400–720 V (special designs for up to 12 kV can be built)
- Connection: HV winding: delta
LV winding: star (up to 100 kVA: zigzag)
- Impedance voltage at rated current: 4% (only up to HV rating 24 kV and ≤ 630 kVA) or 6% (with rated power ≥ 630 kVA or with HV rating > 24 kV)
- Cooling: ONAN
- Protection class: IP00
- Final coating: RAL 7033 (other colours are available)

U_m [kV]	LI [kV]	AC [kV]
1.1	–	3
12	75	28
24	125	50
36	170	70

- LI Lightning-impulse test voltage
- AC Power-frequency test voltage

Fig. 23: Insulation level (IP00)

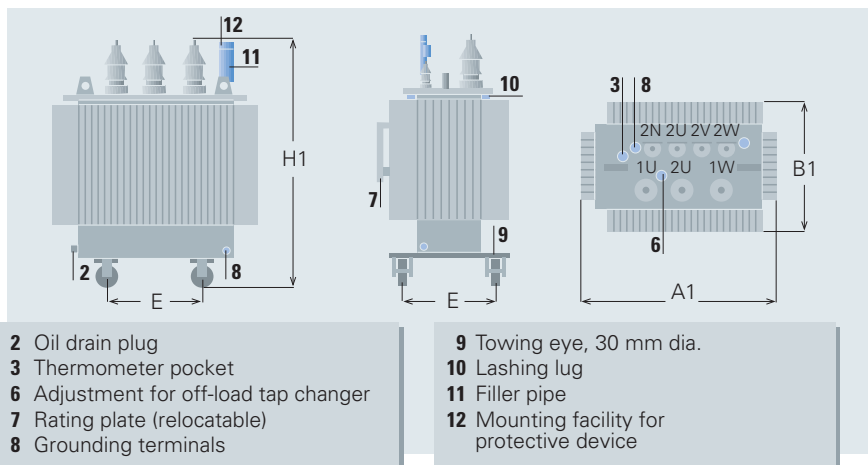
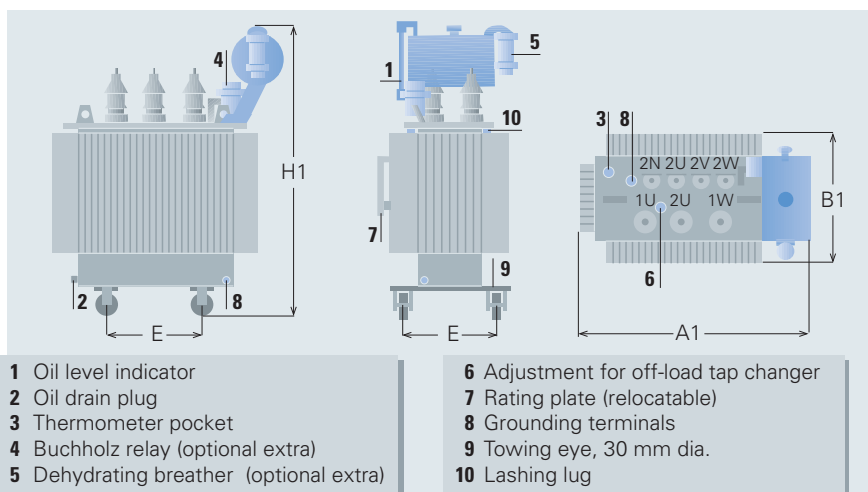

Fig. 24: TUMETIC distribution transformer (sealed tank)



Notes: Tank with strong corrugated walls shown in illustration is the preferred design. With HV ratings up to 24 kV and rated power up to 250 kVA (and with HV ratings > 24 –36 kV and rated power up to 800 kVA), the conservator is fitted on the long side just above the LV bushings.

Fig. 25: TUNORMA distribution transformer (with conservator)

Losses

The standard HD 428.1.S1 (= DIN 42500 Part 1) applies to three-phase oil-immersed distribution transformers 50 Hz, from 50 kVA to 2500 kVA, U_m to 24 kV.

For load losses (P_l), three different listings (A, B and C) were specified. There were also three listings (A', B' and C') for no-load losses (P_0) and corresponding sound levels.

Due to the different requirements, pairs of values were proposed which, in the national standard, permit one or several combinations of losses.

DIN 42500 specifies the combinations A-C', C-C' and B-A' as being most suitable.

The combinations B-A' (normal losses) and A-C' (reduced losses) are approximately in line with previous standards. In addition there is the C-C' combination. Transformers of this kind with additionally reduced losses are especially economical with energy (maximum efficiency $> 99\%$). The higher costs of these transformers are counteracted by the energy savings which they make.

Standard HD 428.3.S1 (= DIN 42500-3) specifies the losses for oil distribution transformers up to $U_m = 36$ kV. For load losses the listings D and E, for no-load losses the listings D' and E' were specified. In order to find the most efficient transformer, please see part "Transformer loss evaluation".

Technical Data Distribution Transformers TUNORMA and TUMETIC

Rated power	Max. rated volt. HV side	Impedance voltage	Type		Combination of losses acc. CENELEC	No-load losses	Load losses	Sound press. level 1 m tolerance + 3 dB	Sound power level	Total weight		Dimensions						Dist. between wheel centers
			TUNORMA	TUMETIC						TUNORMA	TUMETIC	Length A1		Width B1		Height H1		
S_n [kVA]	U_n [kV]	U_2 [%]	4JB...	4HB...		P_0 [W]	P_k 75* [W]	L_{PA} [dB]	L_{WA} [dB]	[kg]	[kg]	[mm]	[mm]	[mm]	[mm]	[mm]	[mm]	E [mm]
50	12	4	..4744-3LB	B-A'		190	1350	42	55	340	350	860	980	660	660	1210	1085	520
		4	..4744-3RB	A-C'		125	1100	34	47	400	430	825	1045	660	660	1210	1085	520
		4	..4744-3TB	C-C'		125	875	34	47	420	440	835	985	660	660	1220	1095	520
	24	4	..4767-3LB	B-A'		190	1350	42	55	370	380	760	860	660	660	1315	1235	520
		4	..4767-3RB	A-C'		125	1100	34	47	430	460	860	860	660	660	1300	1220	520
		4	..4767-3TB	C-C'		125	875	33	47	480	510	880	1100	685	660	1385	1265	520
	36	6	..4780-3CB	E-D'		230	1450	x	52	500	x	1000	x	710	x	1530	x	520
100	12	4	..5044-3LB	B-A'		320	2150	45	59	500	500	1090	1020	660	660	1275	1110	520
		4	..5044-3RB	A-C'		210	1750	35	49	570	570	980	980	660	660	1315	1145	520
		4	..5044-3TB	C-C'		210	1475	35	49	600	620	1030	930	660	660	1320	1150	520
	24	4	..5067-3LB	B-A'		320	2150	45	59	520	530	1020	1140	685	660	1360	1245	520
		4	..5067-3RB	A-C'		210	1750	35	49	600	610	1030	1030	690	660	1400	1280	520
		4	..5067-3TB	C-C'		210	1475	35	49	640	680	960	1060	695	660	1425	1305	520
	36	6	..5080-3CB	E-D'		380	2350	x	56	660	x	1050	x	780	x	1600	x	520
160	12	4	..5244-3LA	B-A'		460	3100	47	62	620	610	1140	1140	710	710	1350	1185	520
		4	..5244-3RA	A-C'		300	2350	37	52	700	690	1130	1010	660	660	1390	1220	520
		4	..5244-3TA	C-C'		300	2000	38	52	760	780	985	1085	660	660	1380	1215	520
	24	4	..5267-3LA	B-A'		460	3100	47	62	660	640	1150	1150	695	660	1440	1320	520
		4	..5267-3RA	A-C'		300	2350	37	52	730	730	1030	930	695	660	1540	1420	520
		4	..5267-3TA	C-C'		300	2000	37	52	800	820	1120	1120	710	660	1475	1355	520
	36	6	..5280-3CA	E-D'		520	3350	x	59	900	x	1120	x	800	x	1700	x	520
(200)	12	4	..5344-3LA	B-A'		550	3600	48	63	720	710	1190	1190	680	680	1450	1285	520
		4	..5344-3RA	A-C'		360	2760	38	53	840	830	1070	1120	660	660	1470	1300	520
		4	..5344-3TA	C-C'		360	2350	38	53	900	920	1130	1130	660	680	1450	1285	520
	24	4	..5367-3LA	B-A'		550	3600	48	63	800	780	1290	1290	820	800	1595	1425	520
		4	..5367-3RA	A-C'		360	2760	38	53	890	910	1110	1230	755	680	1630	1460	520
		4	..5367-3TA	C-C'		360	2350	38	53	950	980	1080	1180	705	690	1595	1430	520
	36	6	..5380-3CA	E-D'		600	3800	x	61	1000	x	1250	x	800	x	1700	x	520

Dimensions and weights are approximate values. Rated power figures in parentheses are not standardized.

x: on request

* In case of short-circuits at 75 °C

Fig. 26: Selection table: oil-immersed distribution transformers 50 to 2500 kVA

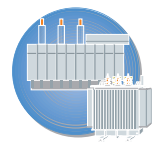

Technical Data Distribution Transformers TUNORMA and TUMETIC

Rated power	Max. rated volt. HV side	Impe- dance voltage	Type		Combi- nation of losses acc. CENELEC	No-load losses	Load losses	Sound press. level 1 m tolerance + 3 dB	Sound power level	Total weight		Dimensions						Dist. between wheel centers
			TUNORMA	TUMETIC						TUNORMA	TUMETIC	Length A1		Width B1		Height H1		
S_n [kVA]	U_n [kV]	U_2 [%]	4JB...	4HB...		P_0 [W]	P_k 75* [W]	L_{PA} [dB]	L_{WA} [dB]	TUNORMA	TUMETIC	TUNORMA	TUMETIC	TUNORMA	TUMETIC	TUNORMA	TUMETIC	[mm]
250	12	4	..5444-3LA	B-A'	650	4200	50	65	830	820	1300	1300	810	810	1450	1285	520	
		4	..5444-3RA	A-C'	425	3250	40	55	940	920	1260	1260	670	820	1480	1415	520	
		4	..5444-3TA	C-C'	425	2750	40	55	1050	1070	1220	1220	690	700	1530	1310	520	
	24	4	..5467-3LA	B-A'	650	4200	49	65	920	900	1340	1340	800	760	1620	1450	520	
		4	..5467-3RA	A-C'	425	3250	39	55	1010	1010	1140	1190	760	680	1675	1510	520	
		4	..5467-3TA	C-C'	425	2750	40	55	1120	1140	1220	1340	715	710	1640	1475	520	
	36	6	..5480-3CA	E-E'	650	4250	x	62	1100	x	1350	x	800	x	1680	x	520	
(315)	12	4	..5544-3LA	B-A'	780	5000	50	66	980	960	1440	1330	820	820	1655	1385	670	
		4	..5544-3RA	A-C'	510	3850	40	56	1120	1100	1400	1250	820	820	1690	1415	670	
		4	..5544-3TA	C-C'	510	3250	40	56	1240	1260	1380	1260	820	820	1665	1390	670	
	24	4	..5567-3LA	B-A'	780	5000	50	66	1050	1030	1450	1350	840	840	1655	1510	670	
		4	..5567-3RA	A-C'	510	3850	40	56	1170	1150	1410	1270	820	820	1755	1610	670	
		4	..5567-3TA	C-C'	510	3250	40	56	1250	1280	1395	1290	820	820	1675	1540	670	
	36	6	..5580-3CA	E-E'	760	5400	x	64	1220	x	1420	x	960	x	1700	x	670	
400	12	4	..5644-3LA	B-A'	930	6000	52	68	1180	1160	1470	1390	930	930	1700	1425	670	
		4	..5644-3RA	A-C'	610	4600	42	58	1320	1310	1400	1360	820	820	1700	1430	670	
		4	..5644-3TA	C-C'	610	3850	42	58	1470	1470	1410	1390	820	820	1695	1420	670	
	24	4	..5667-3LA	B-A'	930	6000	52	68	1240	1220	1570	1570	940	940	1655	1510	670	
		4	..5667-3RA	A-C'	610	4600	42	58	1370	1350	1475	1400	820	820	1760	1615	670	
		4	..5667-3TA	C-C'	610	3850	42	58	1490	1520	1440	1400	820	820	1765	1540	670	
	36	6	..5580-3CA	E-E'	930	6200	x	65	1480	x	1470	x	990	x	1830	x	670	
(500)	12	4	..5744-3LA	B-A'	1100	7100	53	69	1410	1380	1500	1430	840	840	1710	1440	670	
		4	..5744-3RA	A-C'	720	5450	42	59	1650	1620	1560	1550	890	890	1745	1470	670	
		4	..5744-3TA	C-C'	720	4550	43	59	1700	1710	1500	1470	820	820	1745	1470	670	
	24	4	..5767-3LA	B-A'	1100	7100	53	69	1460	1440	1470	1530	835	850	1755	1610	670	
		4	..5767-3RA	A-C'	720	5450	42	59	1650	1620	1495	1420	835	820	1815	1665	670	
		4	..5767-3TA	C-C'	720	4550	43	59	1860	1910	1535	1500	820	820	1860	1645	670	
	36	6	..5780-3CA	E-E'	1050	7800	x	66	1680	x	1510	x	1030	x	1900	x	670	

Dimensions and weights are approximate values. Rated power figures in parentheses are not standardized.

x: on request

* In case of short-circuits at 75 °C

Fig. 27: Selection table: oil-immersed distribution transformers 50 to 2500 kVA

Technical Data Distribution Transformers TUNORMA and TUMETIC

Rated power	Max. rated volt. HV side	Impedance voltage	Type		Combination of losses acc. CENELEC	No-load losses	Load losses	Sound press. level 1 m tolerance + 3 dB	Sound power level	Total weight		Dimensions						Dist. between wheel centers	
			TUNORMA	TUMETIC						TUNORMA	TUMETIC	Length A1		Width B1		Height H1			
S_n [kVA]	U_m [kV]	U_2 [%]	4JB...	4HB...		P_0 [W]	$P_k 75^*$ [W]	L_{PA} [dB]	L_{WA} [dB]	TUNORMA [kg]	TUMETIC [kg]	TUNORMA [mm]	TUMETIC [mm]	TUNORMA [mm]	TUMETIC [mm]	TUNORMA [mm]	TUMETIC [mm]	E [mm]	
630	12	4	..5844-3LA	B-A'		1300	8400	53	70	1660	1660	1680	1480	880	880	1755	1585	670	
		4	..5844-3RA	A-C'		860	6500	43	60	1850	1810	1495	1420	835	820	1785	1510	670	
		4	..5844-3TA	C-C'		860	5400	43	60	2000	1990	1535	1380	820	820	1860	1520	670	
		6	..5844-3PA	B-A'		1200	8700	53	70	1750	1760	1720	1560	890	890	1920	1685	670	
		6	..5844-3SA	A-C'		800	6750	43	60	1950	1920	1665	1600	870	870	1740	1400	670	
		6	..5844-3UA	C-C'		800	5600	43	60	2160	2130	1670	1560	830	830	1840	1500	670	
		24	4	..5867-3LA	B-A'		1300	8400	53	70	1690	1650	1665	1640	860	860	1810	1595	670
			4	..5867-3RA	A-C'		860	6500	43	60	1940	1920	1685	1680	870	870	1910	1695	670
			4	..5867-3TA	C-C'		860	5400	43	60	2100	2130	1600	1490	820	820	1940	1725	670
			6	..5867-3PA	B-A'		1200	8700	53	70	1730	1720	1780	1580	880	880	1760	1610	670
			6	..5867-3SA	A-C'		800	6750	43	60	1970	1960	1645	1640	830	830	1810	1595	670
			6	..5867-3UA	C-C'		800	5600	43	60	2240	2210	1740	1670	880	880	1840	1625	670
	36	6	..5880-3CA	E-E'		1300	8800	x	67	1950	x	1740	x	1080	x	1940	x	670	
(800)	12	6	..5944-3PA	B-A'		1450	10700	55	72	1990	1960	1780	1540	1000	1000	1905	1660	670	
		6	..5944-3SA	A-C'		950	8500	45	62	2210	2290	1720	1830	900	960	1935	1630	670	
		6	..5944-3UA	C-C'		950	7400	44	62	2520	2490	1760	1710	920	920	1975	1730	670	
		24	6	..5967-3PA	B-A'		1450	10700	55	72	2000	1950	1720	1710	1000	1000	1885	1670	670
			6	..5967-3SA	A-C'		950	8500	45	62	2390	2340	1760	1710	960	960	1945	1730	670
			6	..5967-3UA	C-C'		950	7400	44	62	2590	2550	1770	1700	930	930	1985	1780	670
		36	6	..5980-3CA	E-E'		1520	11000	x	68	2400	x	1800	x	1100	x	2030	x	670
1000	12	6	..6044-3PA	B-A'		1700	13000	55	73	2450	2640	1790	1630	1000	1000	2095	2070	820	
		6	..6044-3SA	A-C'		1100	10500	45	63	2660	2610	1830	1830	1040	1040	2025	1770	820	
		6	..6044-3UA	C-C'		1100	9500	45	63	2800	2750	1830	1830	1040	1040	2105	1840	820	
		24	6	..6067-3PA	B-A'		1700	13000	55	73	2530	2720	1830	1670	1090	1010	2095	2120	820
			6	..6067-3SA	A-C'		1100	10500	45	63	2750	2690	1790	1740	1050	1050	2055	1840	820
			6	..6067-3UA	C-C'		1100	9500	45	63	2830	2810	1725	1770	990	990	2065	1850	820
		36	6	..6080-3CA	E-E'		1700	13000	x	68	2850	x	2120	x	1160	x	2220	x	820

Dimensions and weights are approximate values. Rated power figures in parentheses are not standardized.

x: on request

* In case of short-circuits at 75 °C

Fig. 28: Selection table: oil-immersed distribution transformers 50 to 2500 kVA

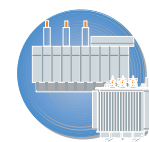

Technical Data Distribution Transformers TUNORMA and TUMETIC

Rated power	Max. rated volt. HV side	Impedance voltage	Type		Combination of losses acc. CENELEC	No-load losses	Load losses	Sound press. level 1 m tolerance + 3 dB	Sound power level	Total weight		Dimensions						Dist. between wheel centers
			TUNORMA	TUMETIC						TUNORMA	TUMETIC	Length A1		Width B1		Height H1		
S_n [kVA]	U_m [kV]	U_2 [%]	4JB... 4HB...			P_0 [W]	P_k 75* [W]	L_{PA} [dB]	L_{WA} [dB]	[kg]		[mm]		[mm]		[mm]		E [mm]
(1250)	12	6	..6144-3PA	B-A'	2100	16000	56	74	2900	3080	1930	1850	1260	1100	2110	2070	820	
		6	..6144-3SA	A-C'	1300	13200	46	64	3100	3040	1810	1780	990	990	2145	1880	820	
		6	..6144-3UA	C-C'	1300	11400	46	64	3340	3040	1755	1720	1015	1000	2235	1970	820	
	24	6	..6167-3PA	B-A'	2100	16000	56	74	2950	3200	2020	1780	1260	1100	2110	2220	820	
		6	..6167-3SA	A-C'	1300	13200	46	64	3190	3120	1840	1810	1060	1060	2115	1900	820	
		6	..6167-3UA	C-C'	1300	11400	46	64	3390	3330	1810	1780	1015	990	2245	2030	820	
	36	6	..6180-3CA	E-E'	2150	16400	x	70	3360	x	2150	x	1250	x	2350	x	820	
1600	12	6	..6244-3PA	B-A'	2600	20000	57	76	3450	3590	1970	1870	1220	1140	2315	2095	820	
		6	..6244-3SA	A-C'	1700	17000	47	66	3640	3590	2030	1760	1080	1090	2315	2010	820	
		6	..6244-3UA	C-C'	1700	14000	47	66	3930	3880	2020	1900	1110	1100	2395	2070	820	
	24	6	..6267-3PA	B-A'	2600	20000	57	76	3470	3690	2070	1830	1280	1120	2335	2320	820	
		6	..6267-3SA	A-C'	1700	17000	47	66	3670	3850	2030	2000	1230	1070	2265	2120	820	
		6	..6267-3UA	C-C'	1700	14000	47	66	4010	3950	2000	1850	1030	1030	2305	2010	820	
	36	6	..6280-3CA	E-E'	2600	19200	x	71	3930	x	2170	x	1340	x	2480	x	820	
(2000)	12	6	..6344-3PA	B-A'	2900	25300	58	78	4390	4450	2100	1890	1330	1330	2555	2540	1070	
		6	..6344-3SA	A-C'	2050	21200	49	68	4270	4430	2080	1840	1330	1330	2455	2250	1070	
		6	..6344-3UA	C-C'	2050	17500	49	68	4730	4710	2020	1730	1330	1330	2495	2170	1070	
	24	6	..6367-3PA	B-A'	2900	25300	58	78	4480	4500	2020	1860	1330	1330	2655	2660	1070	
		6	..6367-3SA	A-C'	2050	21200	49	68	4290	4490	2190	2030	1330	1330	2425	2280	1070	
		6	..6367-3UA	C-C'	2050	17500	49	68	4910	4840	2110	1980	1330	1330	2475	2180	1070	
	36	6	..6380-3CA	E-E'	3200	22000	x	75	5100	x	2260	x	1380	x	2560	x	1070	
2500	12	6	..6444-3PA	B-A'	3500	29000	61	81	5200	5090	2115	2030	1345	1330	2685	2550	1070	
		6	..6444-3SA	A-C'	2500	26500	51	71	5150	5110	2195	1950	1345	1330	2535	2450	1070	
		6	..6444-3UA	C-C'	2500	22000	51	71	5790	5660	2190	2190	1330	1330	2565	2240	1070	
	24	6	..6467-3PA	B-A'	3500	29000	61	81	5420	5220	2115	2030	1335	1330	2785	2675	1070	
		6	..6467-3SA	A-C'	2500	26500	51	71	5260	5220	2195	2030	1335	1335	2585	2580	1070	
		6	..6467-3UA	C-C'	2500	22000	51	71	5640	5470	2160	2080	1330	1330	2605	2305	1070	
	36	6	..6480-3CA	E-E'	3800	29400	x	76	5900	x	2320	x	1390	x	2790	x	1070	

Dimensions and weights are approximate values. Rated power figures in parentheses are not standardized.

x: on request

* In case of short-circuits at 75 °C

Fig. 29: Selection table: oil-immersed distribution transformers 50 to 2500 kVA

Power Transformers – General

Oil-immersed three-phase power transformers with off- and on-load tap changers

Cooling methods

Transformers up to 10 MVA are designed for ONAN cooling. By adding fans to these transformers, the rating can be increased by 25%. However, in general it is more economical to select higher ONAN ratings rather than to add fans.

Transformers larger than 10 MVA are designed with ONAN/ONAF cooling.

Explanation of cooling methods:

- ONAN: Oil-natural, air-natural cooling
- ONAF: Oil-natural, air-forced cooling (in one or two steps)

The arrangement with the attached radiators, as shown in the illustrations, is the preferred design. However, other arrangements of the cooling equipment are also possible.

Depending on transportation possibilities the bushings, radiators and expansion tank have to be removed. If necessary, the oil has to be drained and shipped separately.

Rated power [MVA]	HV range [kV]	Type of tap changer	Figure/ page
3.15 to 10	25 to 123	off-load	Fig. 31, page 5/19
3.15 to 10	25 to 123	on-load	Fig. 33, page 5/20
10/16 to 20/31.5	up to 36	off-load	Fig. 35, page 5/21
10/16 to 20/31.5	up to 36	on-load	Fig. 38, page 5/22
10/16 to 63/100	72.5 to 145	on-load	Fig. 41, page 5/23

Note: Off-load tap changers are designed to be operated de-energized only.

Fig. 30: Types of power transformers

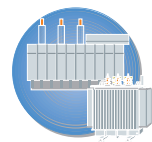

Power Transformers – Selection Tables

Technical Data, Dimensions and Weights

Oil-immersed three-phase power transformers with off-load tap changer
 3150–10000 kVA,
 HV rating: up to 123 kV

- Taps on HV side: $\pm 2 \times 2.5\%$
- Rated frequency: 50 Hz
- Impedance voltage: 6-10 %
- Connection: HV winding: star-delta connection alternatively available up to 24 kV
 LV winding: star or delta

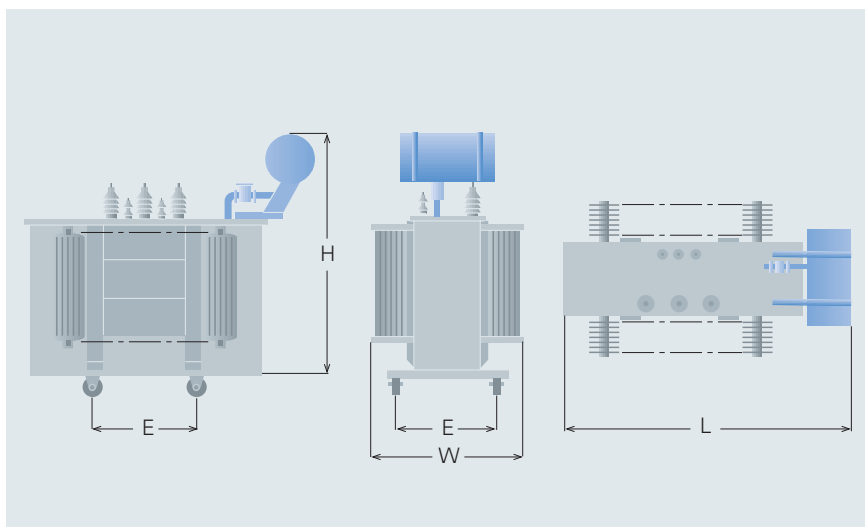

Fig. 31

Rated power [kVA] ONAN	HV rating [kV]	LV rating [kV]	No-load loss [kW]	Load loss at 75 °C [kW]	Total weight [kg]	Oil weight [kg]	Dimensions L/W/H [mm]	E [mm]
3150	6.1–36	3–24	4.6	28	7200	1600	2800/1850/2870	1070
	4000	7.8–36	3–24	5.5	33	8400	1900	3200/2170/2940
5000	50–72.5	3–24	6.8	35	10800	3100	3100/2300/3630	1070
	9.5–36	4–24	6.5	38	9800	2300	2550/2510/3020	1070
	50–72.5	4–24	8.0	41	12200	3300	3150/2490/3730	1070
6300	90–123	5–36	9.8	46	17500	6300	4560/2200/4540	1505
	12.2–36	5–24	7.7	45	11700	2500	2550/2840/3200	1505
	50–72.5	5–24	9.3	48	13600	3700	3200/2690/3080	1505
8000	90–123	5–36	11.0	53	18900	6600	4780/2600/4540	1505
	12.2–36	5–24	9.4	54	14000	3300	2580/2770/3530	1505
	50–72.5	5–24	11.0	56	15900	4200	3250/2850/4000	1505
10000	90–123	5–36	12.5	62	21500	7300	4880/2630/4590	1505
	15.2–36	6–24	11.0	63	16600	3900	2670/2900/3720	1505
	50–72.5	6–24	12.5	65	18200	4700	4060/2750/4170	1505
	90–123	5–36	14.0	72	25000	8600	4970/2900/4810	1505

Fig. 32

Power Transformers – Selection Tables

Technical Data, Dimensions and Weights

Oil-immersed three-phase power transformers with on-load tap changer
3 150–10 000 kVA,
HV rating: up to 123 kV

- Taps on HV side: $\pm 16\%$ in ± 8 steps of 2 %
- Rated frequency: 50 Hz
- Impedance voltage: 6–10 %
- Connection: HV winding: star
LV winding: star or delta

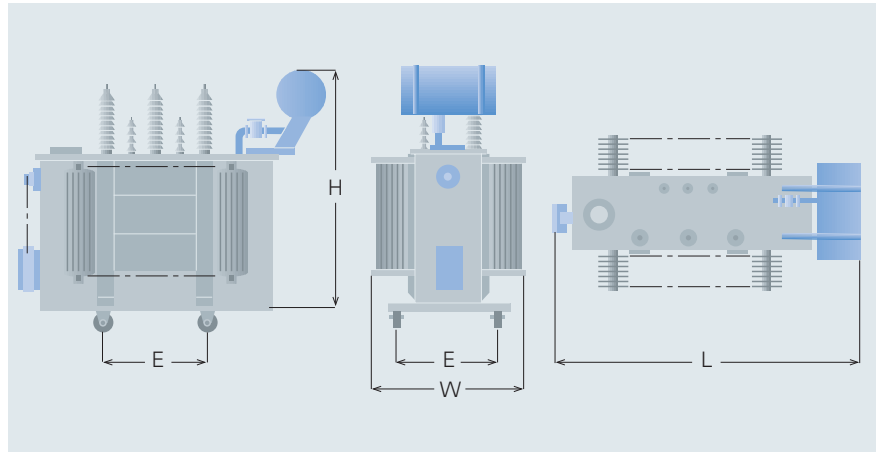
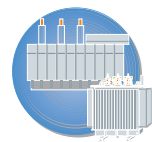

Fig. 33

Rated power [kVA] ONAN	HV rating [kV]	LV rating [kV]	No-load loss kW	Load loss at 75 °C [kW]	Total weight [kg]	Oil weight [kg]	Dimensions L/W/H [mm]	E [mm]
3150	10.9–36	3–24	4.8	29	9100	2300	3400/2300/2900	1070
	4000	9.2–36	3–24	5.8	35	10300	2600	3500/2700/3000
5000	50–72.5	4–24	7.1	37	13700	4100	4150/2350/3600	1070
	11.5–36	4–24	6.8	40	12300	3100	3600/2400/3200	1070
	50–72.5	5–24	8.4	43	15200	4500	4200/2700/3700	1070
6300	90–123	5–36	9.8	49	21800	8000	5300/2700/4650	1505
	14.4–36	5–24	8.1	47	14000	3600	3700/2700/3300	1505
	50–72.5	5–24	9.8	50	17000	5000	4300/2900/3850	1505
8000	90–123	5–36	11.5	56	23000	8500	5600/2900/4650	1505
	18.3–36	5–24	9.9	57	17000	4500	3850/2500/3500	1505
	50–72.5	5–24	11.5	59	19700	6000	4600/2800/4050	1505
10000	90–123	5–36	13.1	65	25500	9000	5650/2950/4650	1505
	22.9–36	6–24	11.5	66	20000	5200	4400/2600/3650	1505
	50–72.5	6–24	13.1	68	22500	6500	5200/2850/4100	1505
	90–123	5–36	14.7	76	29500	10250	5750/2950/4700	1505

Fig. 34



Power Transformers – Selection Tables

Technical Data, Dimensions and Weights

Oil-immersed three-phase power transformers with off-load tap changer
 10/16 to 20/31.5 MVA
 HV rating: up to 36 kV

- Rated frequency: 50 Hz, tapping range $\pm 2 \times 2.5\%$
- Connection of HV winding: star
- Connection of LV winding: star or delta
- Cooling method: ONAN/ONAF
- LV range: 6 kV to 36 kV

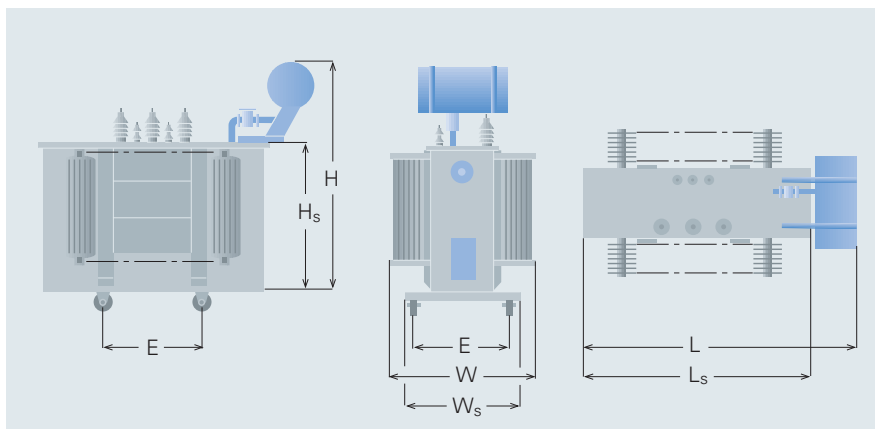

Fig. 35

Rated power at		No-load loss	Load loss at		Impedance voltage of	
ONAN	ONAF		ONAN	ONAF	ONAN	ONAF
[MVA]	[MVA]	[kW]	[kW]	[kW]	[%]	[%]
10	16	12	31	80	6.3	10
12.5	20	14	37	95	6.3	10
16	25	16	45	110	6.4	10
20	31.5	19	52	130	6.4	10

Fig. 36

Rated power at		Dimensions			Total weight	Oil weight	Shipping dimensions			Shipping weight incl. oil
ONAN	ONAF	L	W	H			L _s	W _s	H _s	
[MVA]	[MVA]	[mm]			[kg]	[kg]	[mm]			[kg]
10	16	3700	2350	3900	22	4200	3600	1550	2650	22000
12.5	20	3800	2350	4000	25	4500	3700	1600	2800	23000
16	25	3900	2400	4100	30	5000	3800	1600	2800	27000
20	31.5	4200	2450	4600	35	5700	3900	1650	3000	31500

Fig. 37

Power Transformers – Selection Tables

Technical Data, Dimensions and Weights

Oil-immersed three-phase power transformer with on-load tap changer 10/16 to 20/31.5 MVA, HV rating: up to 36 kV

- Rated frequency: 50 Hz, tapping range $\pm 16\%$ in ± 9 steps
- Connection of HV winding: star
- Connection of LV winding: star or delta
- Cooling method: ONAN/ONAF
- LV range: 6 kV to 36 kV

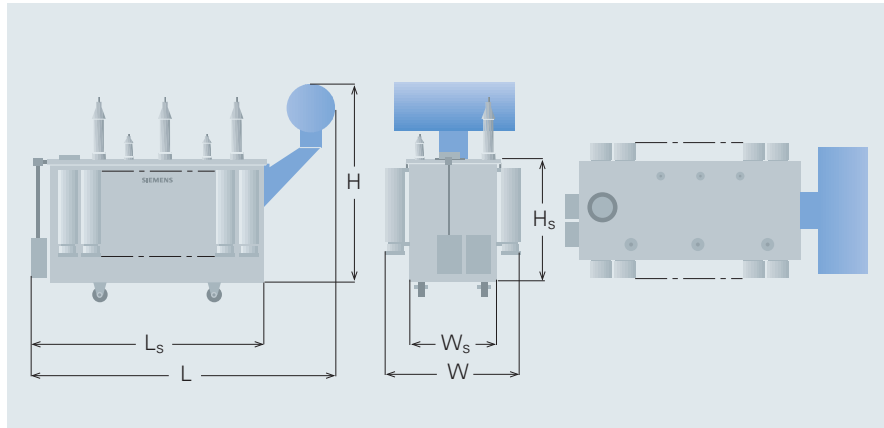

Fig. 38

Rated power at ONAN / ONAF		No-load loss	Load loss at ONAN / ONAF		Impedance voltage of ONAN / ONAF	
[MVA]	[MVA]		[kW]	[kW]	[%]	[%]
10	16	12	31	80	6.3	10
12.5	20	14	37	95	6.3	10
16	25	16	45	111	6.4	10
20	31.5	19	52	130	6.4	10

Fig. 39

Rated power at ONAN / ONAF		Dimensions L x W x H			Total weight	Oil weight	Shipping dimensions L _s x W _s x H _s			Shipping weight incl. oil
[MVA]	[MVA]	[mm]					[kg]	[kg]	[mm]	
10	16	4800	2450	3900	27000	6200	4400	1550	2600	24000
12.5	20	4900	2500	4000	30000	6700	4500	1600	2650	27000
16	25	5050	2500	4100	34000	7000	4650	1650	2650	31000
20	31.5	5300	2550	4600	41000	9000	5000	1700	3000	37000

Fig. 40

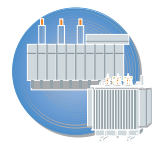

Power Transformers – Selection Tables

Technical Data, Dimensions and Weights

Oil-immersed three-phase power transformers with on-load tap changer
10/16 to 63/100 MVA,
HV rating: from 72.5 to 145 kV

- Rated frequency: 50 Hz, tapping range $\pm 16\%$ in ± 9 steps
- Connection of HV winding: star
- Connection of LV winding: star or delta
- Cooling method: ONAN/ONAF

Rated power at		No-load loss	Load loss at		Impedance voltage of	
ONAN	ONAF		ONAN	ONAF	ONAN	ONAF
[MVA]	[MVA]	[kW]	[kW]	[kW]	[%]	[%]
10	16	13	42	108	9.6	15.4
12.5	20	15	45	115	9.4	15.0
16	25	17	51	125	9.6	15.0
20	31.5	20	56	140	9.6	15.1
25	40	24	63	160	9.5	15.2
31.5	50	28	71	180	9.5	15.0
40	63	35	86	214	9.8	15.5
50	80	41	91	232	10.0	16.0
63	100	49	113	285	10.5	16.7

Fig. 41

Rated power at		Dimensions			Total weight	Oil weight	Shipping dimensions			Shipping weight incl. oil
ONAN	ONAF	L	W	H			L _s	W _s	H _s	
[MVA]	[MVA]	[mm]			[kg]	[kg]	[mm]			[kg]
10	16	6600	2650	4700	39000	12000	5200	1900	3000	35000
12.5	20	6700	2700	4800	43000	12500	5300	1950	3100	39000
16	25	6750	2750	5300	48000	13500	5400	2000	3000	43000
20	31.5	6800	2800	5400	54000	14000	5500	2000	3100	49000
25	40	6900	2900	5400	61000	14500	5700	2100	3150	56000
31.5	50	7050	2950	5500	70000	17000	5850	2150	3350	65000
40	63	7100	3000	5700	82000	18000	6100	2200	3450	75000
50	80	7400	3100	5800	97000	20500	6250	2300	3700	90000
63	100	7800	3250	6100	118000	25500	6800	2450	4000	109000

Fig. 42

Power Transformers above 100 MVA



The power rating range above 100 MVA comprises mainly generator transformers and system-interconnecting transformers with off-load and/or on-load tap changers. Depending on the on-site requirements, they can be designed as transformers with separate windings or as autotransformers, three- or single-phase, for power ratings up to over 1000 MVA and voltages up to 1500 kV. We manufacture these units according to IEC 76, VDE 0532 or other national specifications. Offers for transformers larger than 100 MVA only on request.

5

Fig. 43: Coal-fired power station in Germany with two 850-MVA generator transformers: Low-noise design, extended setting range and continuous overload capacity up to 1100 MVA

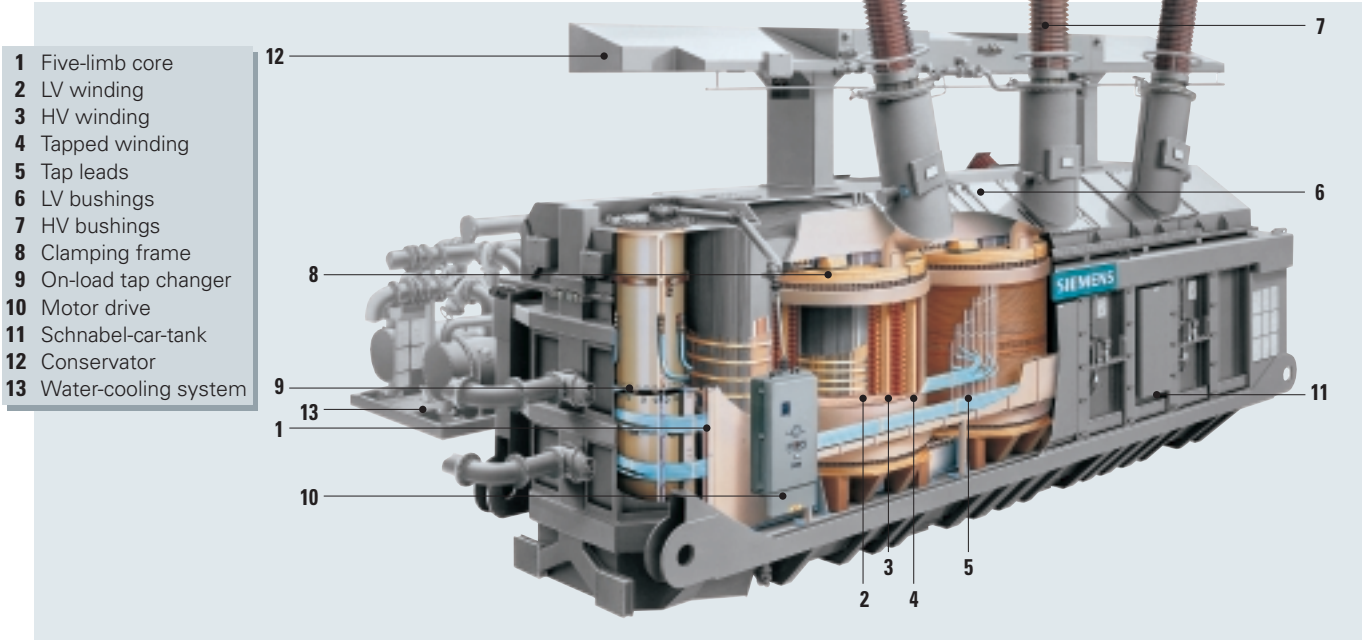
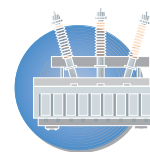

Fig. 44: View into an 850/1100-MVA generator transformer



Power Transformers Monitoring System

Siemens Monitoring System: Efficient Condition Recording and Diagnosis for Power Transformers

Complete acquisition and evaluation of up to 45 measured variables, automatic trend analysis, diagnosis and early warning – the new Siemens Monitoring System makes use of all possible ways of monitoring power transformers: Round the clock, with precision sensors for voltage, temperature or quality of insulation, and with powerful software for measured data processing, display or documentation – with on-line communication over any distance.

Maintenance and utilization of power transformers are made more efficient all-round. Because the comprehensive information provided on the condition of the equipment and auxiliaries ensures that maintenance is carried out just where it's needed, costly routine inspections are a thing of the past. And because the maintenance is always preventive, faults are reliably ruled out.

All these advantages enhance availability – and thus ensure a long service life of your power transformers. This applies equally to new and old transformers.

Equipping new transformers with the Siemens Monitoring System ensures that right from the start the user is in possession of all essential data—for quick, comprehensive analysis. And retrofitting on transformers already in service for considerable periods pays off as well.

Particularly in the case of old transformers, constant monitoring significantly reduces the growing risk of failure.

Offers for transformers larger 100 MVA only on request.



Fig. 45: An integrated solution – the complete Monitoring System housed in a cubicle of the transformer itself

On-load Tap Changers

The on-load tap changers installed in Siemens power transformers are manufactured by Maschinenfabrik Reinhausen (MR). MR is a supplier of technically advanced on-load tap changers for oil-immersed power transformers covering an application range from 100 A to 4,500 A and up to 420 kV. About 90,000 MR high-speed resistor-type tap changers are successfully in service worldwide.

The great variety of tap changer models is based on a modular system which is capable of meeting the individual customer's specifications for the respective operating conditions of the transformer. Depending on the required application range selector, switches or diverter switches with tap selectors can be used, both available for neutral, delta or single-pole connection. Up to 107 operating positions can be achieved by the use of a multiple course tap selector.

In addition to the well-known on-load tap-changer for installation in oil-immersed transformers, MR offers also a standardized gas-insulated tap changer for indoor installation which will be mounted on dry-type transformers up to approx. 30 MVA and 36 kV, or SF₆-type transformers up to 40 MVA and 123 kV.

The main characteristics of MR products are:

- Compact design
- Optimum adaption and economic solutions offered by the great number of variants
- High reliability
- Long life
- Reduced maintenance
- Service friendliness

The tap changers are mechanically driven – via the drive shafts and the bevel gear – by a motor drive attached to the transformer tank. It is controlled according to the step-by-step principle. Electrical and mechanical safety devices prevent over-running of the end positions. Further safety measures, such as the automatic restart function, a safety circuit to prevent false phase sequence and running through positions, ensure the reliable operation of motor drives.

For operation under extremely onerous conditions an oil filter unit is available for filtering or filtering and drying of the switching oil. Voltage monitoring is effected by microprocessor-controlled operation control systems or voltage regulators which include a great variety of data input and output facilities.

In combination with a parallel control unit, several transformers connected in parallel can be automatically controlled and monitored.

Furthermore, Maschinenfabrik Reinhausen offers a worldwide technical service to maintain their high quality standard. Inspections at regular intervals with only small maintenance requirements guarantee the reliable operation expected with MR products.



Fig. 46: MR motor drive ED 100 S

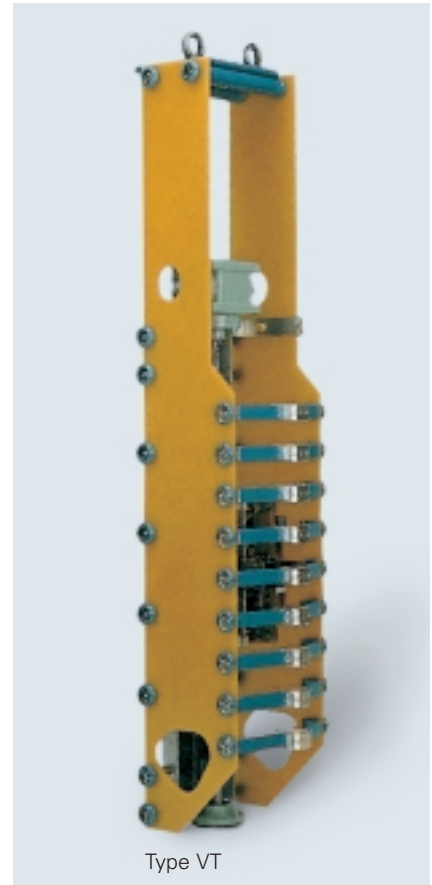

Fig. 47: Gas-insulated on-load tap changer

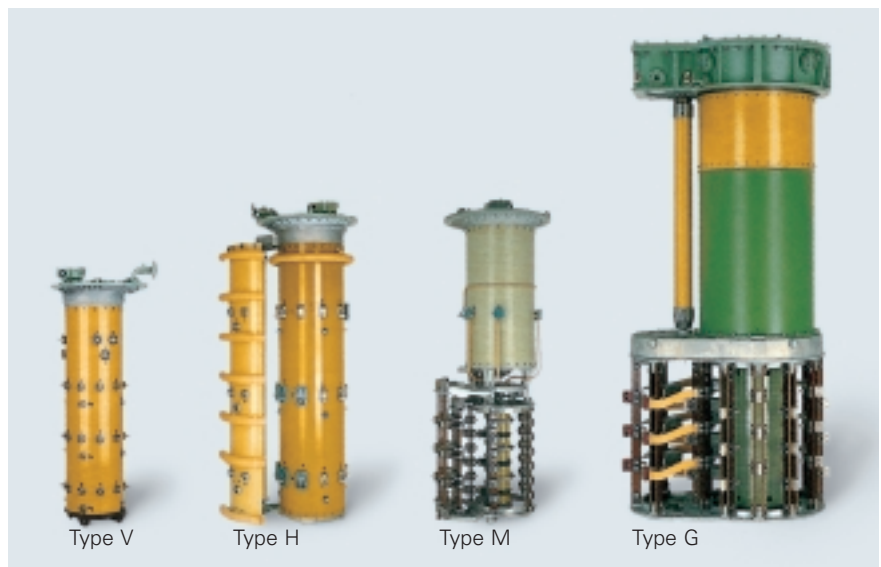

Fig. 48: Selection of on-load tap changers from the MR product range



Cast-resin Dry-type Transformers, GEAFOLE

Standards and regulations

GEAFOL® cast-resin dry-type transformers comply with IEC recommendation No. 726, CENELEC HD 464, HD 538 and DIN 42 523.

Advantages and applications

GEAFOL distribution and power transformers in ratings from 100 to more than 20 000 kVA and LI values up to 170 kV are full substitutes for oil-immersed transformers with comparable electrical and mechanical data.

GEAFOL transformers are designed for indoor installation close to their point of use at the center of the major consumers.

They only make use of flame-retardant inorganic insulating materials which free these transformers from all restrictions that apply to oil-filled electrical equipment, such as oil-collecting pits, fire walls, fire-extinguishing equipment, etc.

GEAFOL transformers are installed wherever oil-filled units cannot be used: inside buildings, in tunnels, on ships, cranes and offshore platforms, in ground-water catchment areas, in food processing plants, etc. Often they are combined with their primary and secondary switchgear and distribution boards into compact substations that are installed directly at their point of use.

As thyristor-converter transformers for variable speed drives they can be installed together with the converters at the drive

location. This reduces civil works, cable costs, transmission losses, and installation costs.

GEAFOL transformers are fully LI-rated. They have similar noise levels to comparable oil-filled transformers. Taking the above indirect cost reductions into account, they are also frequently cost-competitive. By virtue of their design, GEAFOLE transformers are completely maintenance-free for their lifetime.

GEAFOL transformers have been in successful service since 1965. A lot of licenses have been granted to major manufacturers throughout the world since.

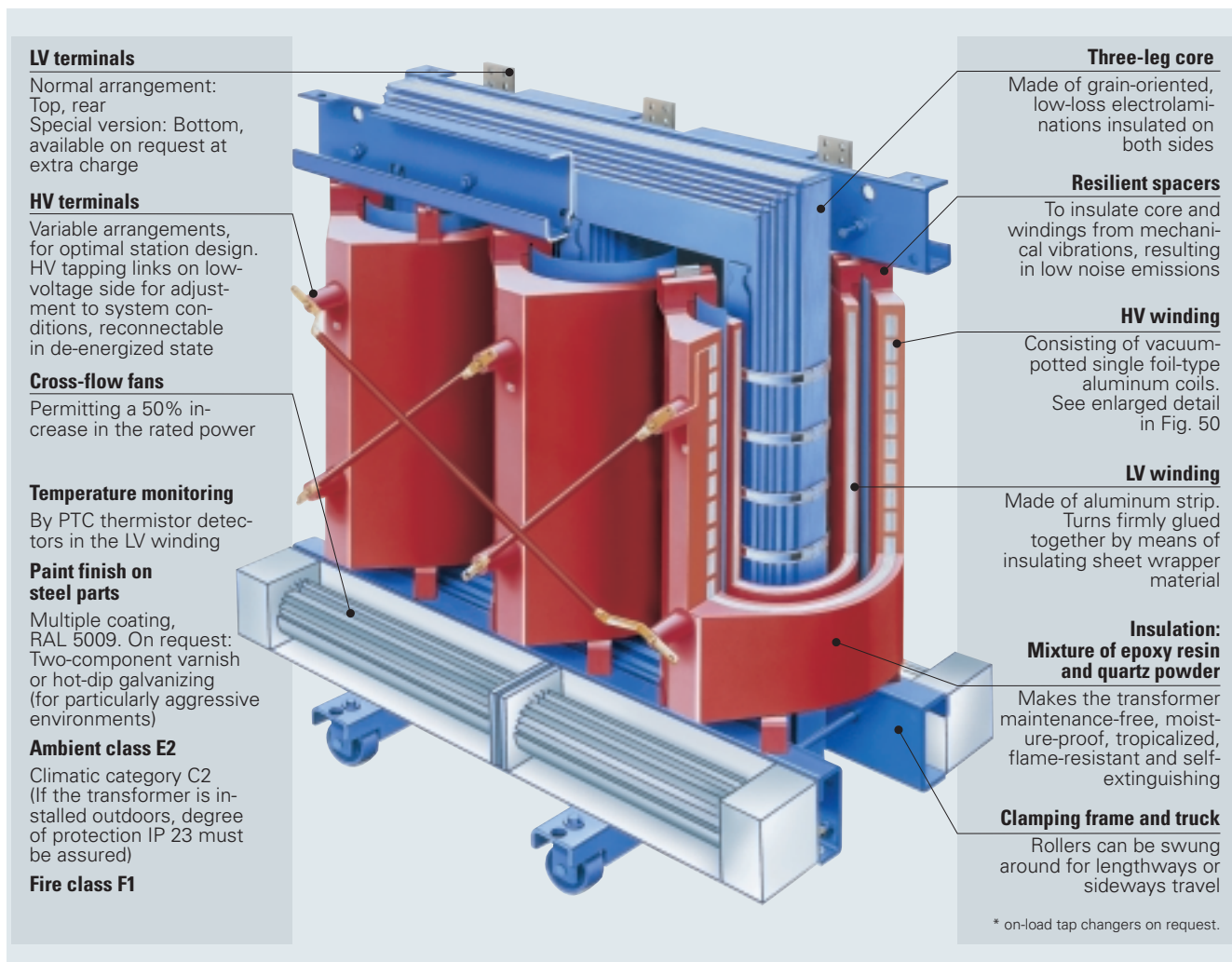

Fig. 49: GEAFOLE cast-resin dry-type transformer

Cast-resin Dry-type Transformers, GEAFOLE

HV winding

The high-voltage windings are wound from aluminum foil, interleaved with high-grade polypropylene insulating foil. The assembled and connected individual coils are placed in a heated mold, and are potted in a vacuum furnace with a mixture of pure silica (quartz sand) and specially blended epoxy resins. The only connections to the outside are copper bushings, which are internally bonded to the aluminum winding connections. The external star or delta connections are made of insulated copper connectors to guarantee an optimal installation design. The resulting high-voltage windings are fire-resistant, moistureproof, corrosion-proof, and show excellent aging properties under all indoor operating conditions. (For outdoor use, specially designed sheet-metal enclosures are available.)

The foil windings combine a simple winding technique with a high degree of electrical safety. The insulation is subjected to less electrical stress than in other types of windings. In a conventional round-wire winding, the interturn voltage can add up to twice the interlayer voltage, while in a foil winding it never exceeds the voltage per turn because a layer consists of only one winding turn. Result: a high AC voltage and impulse-voltage withstand capacity.

Why aluminum? The thermal expansion coefficients of aluminum and cast resin are so similar that thermal stresses resulting from load changes are kept to a minimum (see Fig. 50).

LV winding

The standard low-voltage winding with its considerably reduced dielectric stresses is wound from single aluminum sheets with interleaved cast-resin impregnated fiberglass fabric.

The assembled coils are then oven-cured to form uniformly bonded solid cylinders that are impervious to moisture. Through the single-sheet winding design, excellent dynamic stability under short-circuit conditions is achieved. Connections are submerged-arc-welded to the aluminum sheets and are extended either as aluminum or copper busbars to the secondary terminals.

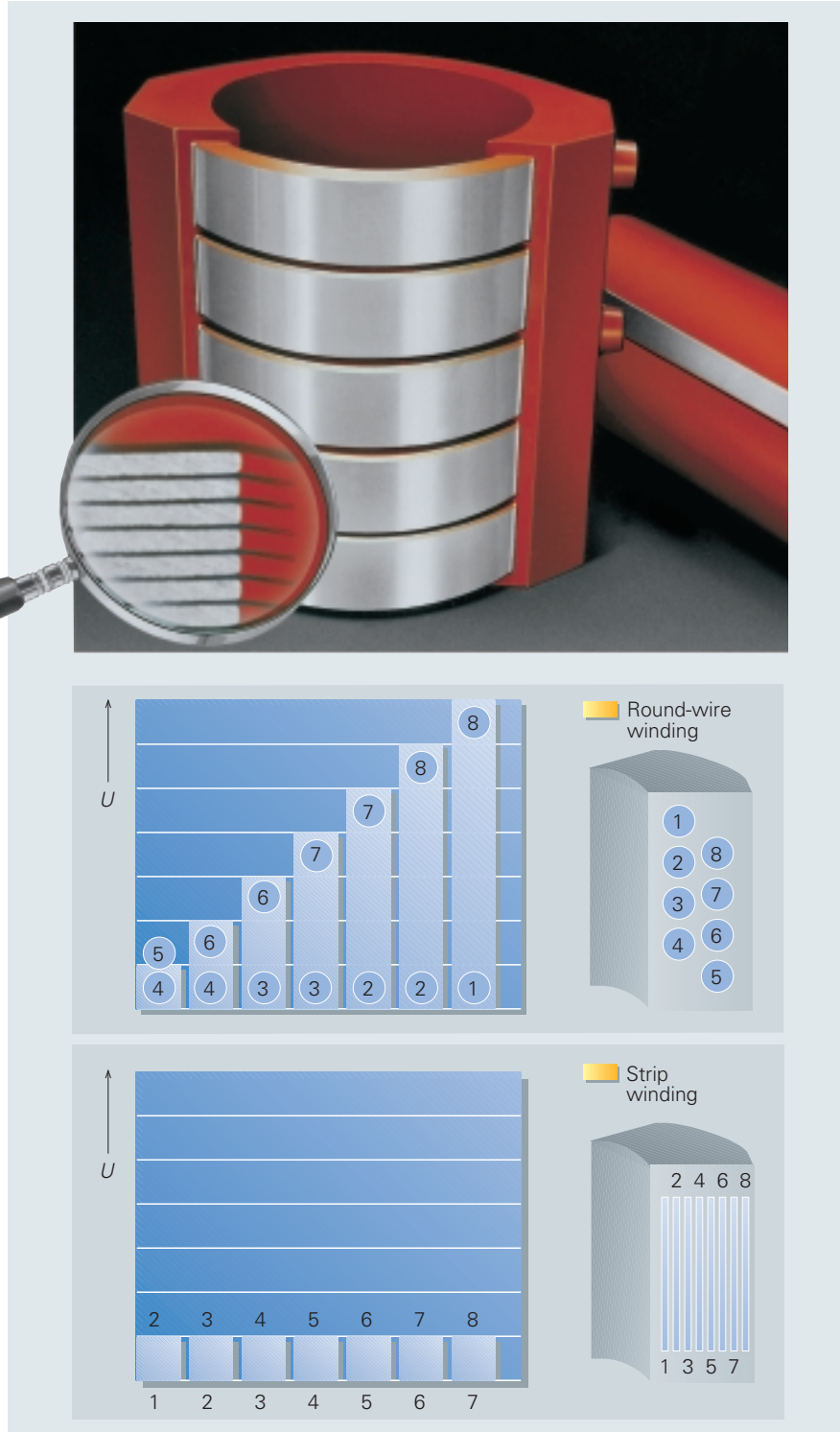

Fig. 50: High-voltage encapsulated winding design of GEAFOLE cast-resin transformer and voltage stress of a conventional round-wire winding (above) and the foil winding (below)



Cast-resin Dry-type Transformers, GEAFOL

Fire safety

GEAFOL transformers use only flame-retardant and self-extinguishing materials in their construction. No additional substances, such as aluminum oxide trihydrate, which could negatively influence the mechanical stability of the cast-resin molding material, are used. Internal arcing from electrical faults and externally applied flames do not cause the transformers to burst or burn. After the source of ignition is removed, the transformer is self-extinguishing. This design has been approved by fire officials in many countries for installation in populated buildings and other structures.

The environmental safety of the combustion residues has been proven in many tests.

Categorization of cast-resin transformers

Dry-type transformers have to be categorized under the sections listed below:

- Environmental category
- Climatic category
- Fire category

These categories have to be shown on the rating plate of each dry-type transformer.

The properties laid down in the standards for ratings within the approximate category relating to environment (humidity), climate and fire behavior have to be demonstrated by means of tests.

These tests are described for the environmental category (code number E0, E1 and E2) and for the climatic category (code number C1, C2) in DIN VDE 0532 Part 6 (corresponding to HD 464). According to this standard, they are to be carried out on complete transformers.

The tests of fire behavior (fire category code numbers F0 and F1) are limited to tests on a duplication of a complete transformer. It consists of a core leg, a low-voltage winding and a high-voltage winding. The specifications for fire category F2 are determined by agreement between the manufacturer and the customer.

Siemens have carried out a lot of tests.

The results for our GEAFOL transformers are something to be proud of:

- Environmental category E2
- Climatic category C2
- Fire category F1

This good behavior is solely due to the GEAFOL cast-resin mix which has been used successfully for decades.

Insulation class and temperature rise

The high-voltage winding and the low-voltage winding utilize class F insulating materials with a mean temperature rise of 100 K (standard design).

Overload capability

GEAFOL transformers can be overloaded permanently up to 50% (with a corresponding increase in impedance voltage) if additional radial cooling fans are installed. (Dimensions increase by approximately 200 mm in length and width.) Short-time overloads are uncritical as long as the maximum winding temperatures are not exceeded for extended periods of time.

Temperature monitoring

Each GEAFOL transformer is fitted with three temperature sensors installed in the LV winding, and a solid-state tripping device with relay output. The PTC thermistors used for sensing are selected for the applicable maximum hot-spot winding temperature. Additional sets of sensors with lower temperature points can be installed for them and for fan control purposes. Additional dial-type thermometers and Pt100 are available, too. For operating voltages of the LV winding of 3.6 kV and higher, special temperature measuring equipment can be provided.

Auxiliary wiring is run in protective conduit and terminated in a central LV terminal box (optional). Each wire and terminal is identified, and a wiring diagram is permanently attached to the inside cover of this terminal box.

Installation and enclosures

Indoor installation in electrical operating rooms or in various sheet-metal enclosures is the preferred method of installation. The transformers need only be protected against access to the terminals or the winding surfaces, against direct sunlight, and against water. Sufficient ventilation must be provided by the installation location or the enclosure. Otherwise forced-air cooling must be specified or provided by others.



Fig. 51: Flammability test of cast-resin transformer

Cast-resin Dry-type Transformers, GEAFOLE

Instead of the standard open terminals, insulated plug-type elbow connectors can be supplied for the high-voltage side with LI ratings up to 170 kV. Primary cables are usually fed to the transformer from trenches below, but can also be connected from above.

Secondary connections can be made by multiple insulated cables, or by busbars, from either below or above. Secondary terminals are either aluminum or copper busbar stubs, drilled to specification.

A variety of indoor and outdoor enclosures in different protection classes are available for the transformers alone, or for indoor compact substations in conjunction with high- and low-voltage switchgear cubicles.

Recycling of GEAFOLE transformers

Of all the GEAFOLE transformers manufactured since 1965, even the oldest units are not about to reach the end of their service life expectancy. In spite of this, a lot of experiences have been made over the years with the recycling of coils that have become unusable due to faulty manufacture or damage. These experiences show that all the metallic components, i.e. approx. 90% of all materials, can be fully recovered economically. The recycling method used by Siemens does not pollute the environment. In view of the value of the secondary raw materials, the procedure can be economical even considering the currently small amounts.



Fig. 52: GEAFOLE transformer with plug-type cable connections



Fig. 53: Radial cooling fans on GEAFOLE transformer for AF cooling



Fig. 54: GEAFOLE transformer in protective housing to IP 20/40



GAEFOL Cast-resin Selection Tables, Technical Data, Dimensions and Weights

- Standard: DIN 42523
- Rated power: 100–20000 kVA*
- Rated frequency: 50 Hz
- HV rating: up to 36 kV
- LV rating: up to 780 V; special designs for up to 12 kV are possible
- Tappings on HV side: $\pm 2.5\%$ or $\pm 2 \times 2.5\%$
- Connection: HV winding: delta
LV winding: star
- Impedance voltage at rated current: 4–8 %
- Insulation class: HV/LV = F/F
- Temperature rise: HV/LV = 100/100 K
- Color of metal parts: RAL 5009 (other colors are available)

U_m [kV]	LJ [kV]	AC [kV]
1.1	–	3
12	75	28
24	95**	50
36	145**	70

* power rating > 2.5 MVA upon request
** other levels upon request

Fig. 55: Insulation level

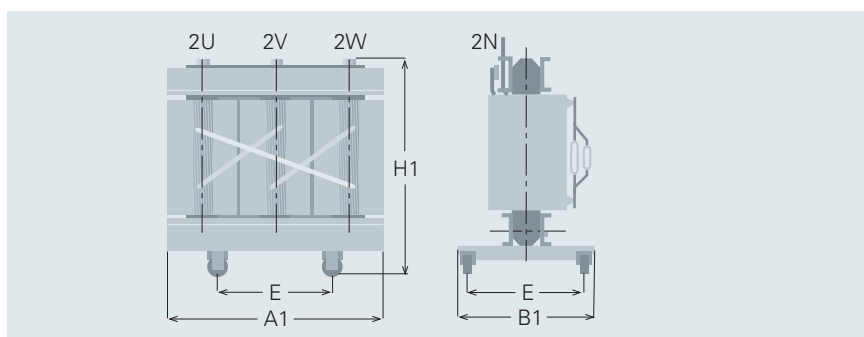

Fig. 56: GAEFOL cast-resin transformer

Rated power	Rated voltage	Impedance voltage	Type	No-load losses	Load losses	Load losses	Sound press. level 1 m tolerance + 3 dB	Sound power level	Total weight	Dimensions			Distance between wheel centers
										Length	Width	Height	
S_n [kVA]	U_m [kV]	U_2 [%]	4GB...	P_0 [W]	$P_k 75^*$ [W]	$P_k 120^{**}$ [W]	L_{PA} [dB]	L_{WA} [dB]	GGES [kg]	A1 [mm]	B1 [mm]	H1 [mm]	E [mm]
100	12	4	.5044-3CA	440	1600	1900	45	59	630	1210	705	835	without wheels
			.5044-3GA	320	1600	1900	37	51	760	1230	710	890	without wheels
		6	.5044-3DA	360	2000	2300	45	59	590	1190	705	860	without wheels
			.5044-3HA	300	2000	2300	37	51	660	1230	710	855	without wheels
	24	4	.5064-3CA	600	1500	1750	45	59	750	1310	755	935	without wheels
			.5064-3GA	400	1500	1750	37	51	830	1300	755	940	without wheels
		6	.5064-3DA	420	1800	2050	45	59	660	1250	750	915	without wheels
			.5064-3HA	330	1800	2050	37	51	770	1300	755	930	without wheels
160	12	4	.5244-3CA	610	2300	2600	47	62	770	1220	710	1040	520
			.5244-3GA	440	2300	2600	39	54	920	1290	720	1050	520
		6	.5244-3DA	500	2300	2700	47	62	750	1270	720	990	520
			.5244-3HA	400	2300	2700	39	54	850	1300	725	985	520
	24	4	.5264-3CA	800	2200	2500	47	62	910	1330	725	1090	520
			.5264-3GA	580	2200	2500	39	54	940	1310	720	1095	520
		6	.5264-3DA	600	2500	2900	47	62	820	1310	725	1075	520
			.5264-3HA	480	2500	2900	39	54	900	1350	765	1060	520

Dimensions and weights are approximate values and valid for 400 V on the secondary side, vector-group can be Dyn 5 or Dyn 11.

Rated power figures in parentheses are not standardized.

* In case of short-circuits at 75 °C
** In case of short-circuits at 120 °C

Fig. 57: GAEFOL cast-resin transformers 50 to 2500 kVA

GAEFOL Cast-resin Selection Tables, Technical Data, Dimensions and Weights

Rated power	Rated voltage	Impe- dance voltage	Type	No-load losses	Load losses	Load losses	Sound press. level 1 m toler- ance + 3 dB	Sound power level	Total weight	Dimensions			Distance between wheel centers	
										Length	Width	Height		
S_n [kVA]	U_n [kV]	U_2 [%]	4GB...	P_0 [W]	P_k 75* [W]	P_k 120** [W]	L_{PA} [dB]	L_{WA} [dB]	GGES [kg]	A1 [mm]	B1 [mm]	H1 [mm]	E [mm]	
250	12	4	.5444-3CA	820	3000	3500	50	65	1040	1330	730	1110	520	
		4	.5444-3GA	600	3000	3400	42	57	1170	1330	730	1135	520	
		6	.5444-3DA	700	2900	3300	50	65	990	1350	740	1065	520	
		6	.5444-3HA	570	2900	3300	42	57	1120	1390	745	1090	520	
	24	4	.5464-3CA	1050	2900	3300	50	65	1190	1390	735	1120	520	
		4	.5464-3GA	800	2900	3300	41	57	1230	1400	735	1150	520	
		6	.5464-3DA	880	3100	3600	50	65	990	1360	735	1140	520	
		6	.5464-3HA	650	3100	3600	41	57	1180	1430	745	1160	520	
		36	6	.5475-3DA	1300	3800	4370	50	65	1700	1900	900	1350	520
(315)	12	4	.5544-3CA	980	3300	3800	52	67	1160	1370	820	1125	670	
		4	.5544-3GA	720	3300	3800	43	59	1320	1380	820	1195	670	
		6	.5544-3DA	850	3400	3900	51	67	1150	1380	830	1140	670	
		6	.5544-3HA	680	3400	3900	43	59	1290	1410	830	1165	670	
	24	4	.5564-3CA	1250	3400	3900	51	67	1250	1410	820	1195	670	
		4	.5564-3GA	930	3400	3900	43	59	1400	1440	825	1205	670	
		6	.5564-3DA	1000	3600	4100	51	67	1190	1410	825	1185	670	
		6	.5564-3HA	780	3600	4100	43	59	1300	1460	830	1195	670	
		36	6	.5575-3DA	1450	4500	5170	51	67	1900	1950	920	1400	670
400	12	4	.5644-3CA	1150	4300	4900	52	68	1310	1380	820	1265	670	
		4	.5644-3GA	880	4300	4900	44	60	1430	1380	820	1290	670	
		6	.5644-3DA	1000	4300	4900	52	68	1250	1410	825	1195	670	
		6	.5644-3HA	820	4300	4900	44	60	1350	1430	830	1195	670	
	24	4	.5664-3CA	1450	3900	4500	52	68	1410	1440	825	1280	670	
		4	.5664-3GA	1100	3900	4500	44	60	1570	1460	830	1280	670	
		6	.5664-3DA	1200	4100	4700	52	68	1350	1480	835	1275	670	
		6	.5664-3HA	940	4100	4700	44	60	1460	1480	835	1280	670	
		36	6	.5675-3DA	1700	5100	5860	52	68	2100	2000	920	1440	670
(500)	12	4	.5744-3CA	1350	4900	5600	53	69	1520	1410	830	1320	670	
		4	.5744-3GA	1000	4900	5600	45	61	1740	1450	835	1345	670	
		6	.5744-3DA	1200	5600	6400	53	69	1470	1460	845	1275	670	
		6	.5744-3HA	980	5600	6400	45	61	1620	1490	845	1290	670	
	24	4	.5764-3CA	1700	4800	5500	53	69	1620	1500	835	1330	670	
		4	.5764-3GA	1270	4800	5500	44	61	1830	1540	840	1350	670	
		6	.5764-3DA	1400	5000	5700	53	69	1580	1540	850	1305	670	
		6	.5764-3HA	1100	5000	5700	45	61	1720	1560	850	1320	670	
		36	6	.5775-3DA	1900	6000	6900	53	69	2600	2050	940	1500	670

Dimensions and weights are approximate values and valid for 400 V on the secondary side, vector-group can be Dyn 5 or Dyn 11.

Rated power figures in parentheses are not standardized.

* In case of short-circuits at 75 °C
** In case of short-circuits at 120 °C

Fig. 58: GAEFOL cast-resin transformers 50 to 2500 kVA



GFAFOL Cast-resin Selection Tables, Technical Data, Dimensions and Weights

Rated power	Rated voltage	Impedance voltage	Type	No-load losses	Load losses	Load losses	Sound press. level 1 m tolerance + 3 dB	Sound power level	Total weight	Dimensions			Distance between wheel centers
										Length	Width	Height	
S_n [kVA]	U_m [kV]	U_2 [%]	4GB...	P_0 [W]	$P_k 75^*$ [W]	$P_k 120^{**}$ [W]	L_{PA} [dB]	L_{WA} [dB]	GGES [kg]	A1 [mm]	B1 [mm]	H1 [mm]	E [mm]
630	12	4	.5844-3CA	1500	6400	7300	54	70	1830	1510	840	1345	670
		4	.5844-3GA	1150	6400	7300	45	62	2070	1470	835	1505	670
		6	.5844-3DA	1370	6400	7400	54	70	1770	1550	860	1295	670
		6	.5844-3HA	1150	6400	7400	45	62	1990	1590	865	1310	670
	24	4	.5864-3CA	1950	6000	6900	53	70	1860	1550	845	1380	670
		4	.5864-3GA	1500	6000	6900	45	62	2100	1600	850	1400	670
		6	.5864-3DA	1650	6400	7300	53	70	1810	1580	855	1345	670
		6	.5864-3HA	1250	6400	7300	45	62	2050	1620	860	1370	670
36	6	.5875-3DA	2200	7000	8000	53	70	2900	2070	940	1650	670	
	(800)												
	12	4	.5944-3CA	1850	7800	9000	55	72	2080	1570	850	1560	670
		4	.5944-3GA	1450	7800	9000	47	64	2430	1590	855	1640	670
6		.5944-3DA	1700	7600	8700	55	72	2060	1560	865	1490	670	
6		.5944-3HA	1350	7600	8700	47	64	2330	1600	870	1530	670	
24	4	.5964-3CA	2100	7500	8600	55	72	2150	1610	845	1580	670	
	4	.5964-3GA	1600	7500	8600	47	64	2550	1650	855	1620	670	
	6	.5964-3DA	1900	7900	9100	55	71	2110	1610	860	1590	670	
	6	.5964-3HA	1450	7900	9100	47	64	2390	1630	865	1595	670	
36	6	.5975-3DA	2600	8200	9400	55	72	3300	2140	950	1850	670	
	1000												
	12	4	.6044-3CA	2200	8900	10200	55	73	2480	1590	990	1775	820
		4	.6044-3GA	1650	8900	10200	47	65	2850	1620	990	1795	820
6		.6044-3DA	2000	8500	9700	56	73	2420	1620	990	1560	820	
6		.6044-3HA	1500	8500	9700	47	65	2750	1660	990	1560	820	
24	4	.6064-3CA	2400	8700	10000	55	73	2570	1660	990	1730	820	
	4	.6064-3GA	1850	8700	10000	47	65	3060	1680	990	1815	820	
	6	.6064-3DA	2300	9200	10500	55	73	2510	1680	990	1620	820	
	6	.6064-3HA	1750	9600	11000	47	65	2910	1730	990	1645	820	
36	6	.6075-3DA	3000	9500	10900	55	73	3900	2200	1050	1900	820	
	(1250)												
	12	6	.6144-3DA	2400	9600	11000	57	75	2900	1780	990	1605	820
		6	.6144-3HA	1850	10500	12000	49	67	3370	1790	990	1705	820
24	6	.6164-3DA	2700	10000	11500	57	75	3020	1820	990	1635	820	
	6	.6164-3HA	2100	10500	12000	49	67	3490	1850	990	1675	820	
36	6	.6175-3DA	3500	11000	12600	57	75	4500	2300	1060	2000	520	

Dimensions and weights are approximate values and valid for 400 V on the secondary side, vector-group can be Dyn 5 or Dyn 11.

Rated power figures in parentheses are not standardized.

* In case of short-circuits at 75 °C

** In case of short-circuits at 120 °C

Fig. 59: GFAFOL cast-resin transformers 50 to 2500 kVA

GAEFOL Cast-resin Selection Tables, Technical Data, Dimensions and Weights

Rated power	Rated voltage	Impedance voltage	Type	No-load losses	Load losses	Load losses	Sound press. level 1 m tolerance + 3 dB	Sound power level	Total weight	Dimensions			Distance between wheel centers
										Length	Width	Height	
S_n [kVA]	U_m [kV]	U_2 [%]	4GB...	P_0 [W]	P_k 75* [W]	P_k 120** [W]	L_{PA} [dB]	L_{WA} [dB]	GGES [kg]	A1 [mm]	B1 [mm]	H1 [mm]	E [mm]
1600	12	6	.6244-3DA	2800	11000	12500	58	76	3550	1840	995	2025	1070
		6	.6244-3HA	2100	11400	13000	50	68	4170	1880	1005	2065	1070
	24	6	.6264-3DA	3100	11800	13500	58	76	3640	1880	995	2035	1070
		6	.6264-3HA	2400	12300	14000	49	68	4080	1900	1005	2035	1070
	36	6	.6275-3DA	4300	12700	14600	58	76	5600	2500	1100	2400	1070
(2000)	12	6	.6344-3DA	3600	14000	16000	59	78	4380	1950	1280	2150	1070
		6	.6344-3HA	2650	14500	16500	51	70	5140	1990	1280	2205	1070
	24	6	.6364-3DA	4000	14500	16500	59	78	4410	2020	1280	2160	1070
		6	.6364-3HA	3000	14900	17000	51	70	4920	2040	1280	2180	1070
	36	6	.6375-3DA	5100	15400	17700	59	78	6300	2500	1280	2400	1070
2500	12	6	.6444-3DA	4300	17600	20000	62	81	5130	2110	1280	2150	1070
		6	.6444-3HA	3000	18400	21000	51	71	6230	2170	1280	2205	1070
	24	6	.6464-3DA	5000	17600	20000	61	81	5280	2170	1280	2160	1070
		6	.6464-3HA	3600	18000	20500	51	71	6220	2220	1280	2180	1070
	36	6	.6475-3DA	6400	18700	21500	61	81	7900	2700	1280	2400	1070

Dimensions and weights are approximate values and valid for 400 V on the secondary side, vector-group can be Dyn 5 or Dyn 11.

Rated power figures in parentheses are not standardized.

* In case of short-circuits at 75 °C
 ** In case of short-circuits at 120 °C
 Rated power >2500 kVA to 20 MVA on request.

Fig. 60: GAEFOL cast-resin transformers 50 to 2500 kVA

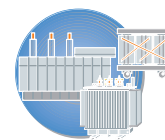

Special Transformers

GEAFOL cast-resin transformers with oil-free tap-changers

The voltage-regulating cast-resin transformers connected on the load side of the medium-voltage power supply system feed the plant-side distribution transformers. The tap-changer-controlled transformers used in these medium-voltage systems need to have appropriately high ratings. Siemens offers suitable transformers in its GEAFOL design which has proved successful over many years and is available in ratings of up to 20 MVA. With forced cooling it is even possible to increase the power ratings still further by 40%. The range of rated voltage extends to 36 kV and the maximum impulse voltage is 200 kV. The main applications of this type of transformer are in modern industrial plants, hospitals, office and apartment blocks and shopping centers.

Linking single-pole tap-changer modules together in threes by means of insulating shafts produces a triple-pole tap-changer in either star or delta connection for regulating the output voltage of GEAFOL transformers. In its nine operating positions, this type of tap-changer has a rated through-current of 500 A and a rated voltage of 900 V per step. This allows voltage fluctuations of up to 8100 V to be kept under control. However, the maximum control range utilizes only 20% of the rated voltage.



Fig. 61: 16/22-MVA GEAFOL cast-resin transformer with oil-free on-load tap changer

Special Transformers

Transformers for thyristor converters

These are special oil-immersed or cast-resin power transformers that are designed for the special demands of thyristor converter or diode rectifier operation. The effects of such conversion equipment on transformers and additional construction requirements are as follows:

- Increased load by harmonic currents
- Balancing of phase currents in multiple winding systems (e.g. 12-pulse systems)
- Overload factor up to 2.5
- Types for 12-pulse systems, if required.

Siemens supplies oil-filled converter transformers of all ratings and configurations known today, and dry-type cast-resin converter transformers up to more than 20 MVA and 200 kV LI.

To define and quote for such transformers, it is necessary to know considerable details on the converter to be supplied and on the line feeding it. These transformers are almost exclusively inquired together with the respective drive or rectifier system and are always custom-engineered for the given application.

Neutral grounding transformers

When a neutral grounding reactor or ground-fault neutralizer is required in a three-phase system and no suitable neutral is available, a neutral must be provided by using a neutral grounding transformer.

Neutral grounding transformers are available for continuous operation or short-time operation.

The zero impedance is normally low. The standard vector groups are zigzag or wye/delta. Some other vector groups are also possible.

Neutral grounding transformers can be built by Siemens in all common power ratings.

Normally, the neutral grounding transformers are built in oil-immersed design, however, they can also be built in cast-resin design.



Fig. 62: Dry-type converter transformer GEAFOLE